

INDUSTRIAL EDUCATION SOLUTIONS



TABLE OF CONTENTS

CERTIFICATIONS, CURRICULUM, & SOFTWARE 2

USE OUR ONLINE TOOL TO NAVIGATE EQUIPMENT AND PROGRAMS..... 4

INDUSTRIAL TRAINING CLASSROOM 6

WE BELIEVE IN EDUCATION..... 8

ROBOTICS

 STAND-ALONE PRODUCTS FOR YOUR CLASSROOM..... 10

 CERT CART..... 11

 ROBOT ACCESSORIES 12

CNC

 FANUC ROBODRILL CNC..... 16

 MTEC - ROBOT MACHINE TENDER 18

 MTEC-SIM - ROBOT WITH CNC SIMULATOR 20

MECHATRONICS

 iCC INDUSTRIAL CONTROLS CENTER - PLC/HMI TRAINER 22

 iIM5.0 - MECHATRONICS CERT CART 24

 AM-CERT - INDUSTRIAL MATERIAL HANDLING TRAINER..... 26

 CSM™ - SMART MANUFACTURING TRAINING SYSTEM..... 28

CONTROLS INTEGRATION 32

WELDING

 Weld CERT Cart - ROBOTIC WELDING TRAINER 34

CLASSROOM DESIGN SERVICES..... 36

“This system was developed to bring alignment between Industry and Education to directly tie into the FANUC CERT program, foundational skills in robotics, vision, and integrated solutions.”

- Paul Aiello
Director of Education
FANUC America Corporation



”

“The success of our training programs has allowed us the opportunity to share the best practices to help other training programs develop the same student outcomes.”

- Anthony Nighswander
President
APT Manufacturing Solutions



”

“Our goal is to integrate Rockwell products with robots to bridge the learning gap. We piece parts together into one great learning system where students can not only learn the technology, but can also understand how to apply it as a system and understand the steps. That’s what our customers really want!”

- Michael Cook
Director
University Partnership Rockwell Automation



”

For most current information, see aptmfg.com/education



CERTIFICATIONS, CURRICULUM, & SOFTWARE



FANUC America Corporation
3900 W. Hamlin Road
Rochester Hills, MI 48309-3253

Telephone: (248) 377-7000
Customer Service Center: (888)-FANUC-US
www.fanucamerica.com

FANUC EDUCATION GRANT

The FANUC America Corporation Certified Education Training (CERT) Program certifies instructors at educational institutions to train their students to program FANUC robots. To accompany the FANUC CERT Program, new school locations receive (1) CERT Instructor Training and Tool Kit and (1) CERT School Comprehensive Educational Package.

All CERT Program Robots include the Advanced CERT Software Configuration for education, which includes: **MH** - Advanced Ethernet I/P Scanner, Advanced Dual Check Safety (DCS), 4D Graphics, Motion Package, PC Remote iPendant, Collision Guard Pack, Interface Panel, Maintenance Package, Menu Utility, Remote iPendant, ROBODRILL Interface. **AT** - Torch Guard, Torch Mate, Collision Guard, 4D Graphics, Payload ID, Touch Sensing and TAST (Through Arm Seam Tracking). Auto Error Recovery, Bump Box, Constant Path, Password Protection, Panel Wizard, KAREL, Menu Utility, Lincoln or Miller Weld Library.

The Industry Value of the Advanced CERT Software Configuration is \$15,240

The (MH or AT) CERT Instructor Training and Tool Kit provides your designated instructor training materials and includes the following deliverables:

- (1) online seat to take CERT Cart Safety Features web course
- (1) online seat to take Robot Operations web course
- (1) online seat to take HandlingTool or ArcTool Operation and Programming web course
- (1) online seat to take HandlingPRO or WeldPRO web course
- (1) seat to take a live HandlingTool or ArcTool Operation and Programming class at a FANUC facility
- (1) ROBOGUIDE Simulation Software license
- (1) FANUC Robot Operations Manual
- (1) FANUC HandlingTool or ArcTool Operations and Programming Manual
- (1) FANUC HandlingPRO (ROBOGUIDE Simulation) Manual

The Industry Value of the CERT Instructor Training and Tool Kit is \$15,500.

The (MH or AT) CERT School Comprehensive Educational Package provides students training tools and ensures your instructor has the necessary tools to effectively teach their students. This package includes the following deliverables:

- (25) concurrent-user seat to take Robot Operations web course
- (25) concurrent-user seat to take HandlingTool or ArcTool Operation and Programming web course
- (25) concurrent-user seat to take HandlingPRO or WeldPRO web course
- (25) ROBOGUIDE Simulation Software license

Industry Value of the CERT School Comprehensive Educational Package is \$290,610(MH) / \$403,240(AT)

To become a certified (MH or AT) CERT instructor, the designated instructor must:

1. Successfully complete the CERT Cart Safety Features web course
2. Successfully complete the Robot Operations web course
3. Successfully complete the HandlingTool or ArcTool Operation and Programming web course
4. Successfully complete the HandlingPRO or WeldPRO web course
5. Attend the live HandlingTool or ArcTool Operation and Programming class at a FANUC facility
6. Pass the online Certified Education Robot Training Test via FANUC eLearn
7. **PASS the NOCTI FANUC (FCR-01) EXAM - Test Fee required through NOCTI (MH only)**
8. Provide an outline of their robotic syllabus/curriculum
9. Provide a video to FANUC of a module/chapter being presented to an audience or faculty staff



SOFTWARE

INCLUDED

1 year subscription of

Rockwell Automation EDU Toolkit Bundle

- Studio 5000 Logix Designer®
- Studio 5000 View Designer,
- plus over 100 more pieces of Rockwell software

Renewable each year through your local distributor.

CURRICULUM

OPTIONAL

(10) seats of Learning+ course content

Renewable each year through your local distributor.



OpenBook™

learning management software



MANUFACTURINGsolutions

Integration Project-Based Learning (PBL) Curriculum

- Daily lesson plans
- Assessment and grade charts

USE OUR ONLINE TOOL TO NAVIGATE EQUIPMENT AND PROGRAMS

<https://aptmfg.com/products/program-overview/>

FANUC Robotics Courses	FANUC CNC Courses	Rockwell Automation Courses
Miller Welding Courses	APT Integration Courses	Industry Recognized Certifications

Learning Level	Career Path	Description	Cert. Type	ROBO-DRILL	CERT Cart	MTEC-SIM	MTEC	Weld CERT Cart	iCC (PLC/HMI)	AM-CERT	CSM	iIM5.0	
Level 1	FANUC Robot Operator - Material Handling	F FANUC: HandlingTool Operation and Programming			✓	✓	✓		✓*	✓	✓	✓	
		F FANUC: HandlingPRO			✓	✓	✓		✓*	✓	✓	✓	
		I FANUC Certification administered by NOCTI: FCR-01 - Written			✓	✓	✓	✓		✓	✓	✓	✓
		I FANUC Certification administered by NOCTI: FCR-02 - Performance			✓	✓	✓	✓		✓	✓	✓	✓
	FANUC Robot Operator - Arc Welding	F FANUC: ArcTool Operation and Programming						✓					
		F FANUC: WeldPRO						✓					
		M Miller OpenBook: Robotic Welding Fundamentals						✓ ^C					
	CNC Operator	M Miller OpenBook: Gas Metal Arc Welding (MIG)						✓ ^C					
		C FANUC CNC Concepts: Machining, Programming, Setup, and Operation			✓		✓	✓ ^C				✓	
		C FANUC CNC Concepts: Turning, Programming, Setup, and Operation			✓		✓	✓ ^C				✓	
	PLC / Controls Operator	I NIMS Certification: CNC Mill Programming Setup, and Operation			✓			✓				✓	
		A Schematic Reading Fundamentals							✓	✓	✓	✓	✓
		A Panel Building Lab							✓				
		R Rockwell CCP 183: Ethernet / IP Configuration and Troubleshooting							✓	✓	✓	✓	✓
		R Rockwell CCP 146: Logix 5000 System Fundamentals							✓	✓	✓	✓	✓

<p>Level 1</p> <p>This coursework will train entry level operators and provide a basic understanding of industrial equipment.</p> <p>This is perfect for a high school, vocational school, or school starting up industrial training.</p>	<p>Level 2</p> <p>This coursework will train technician level employees with troubleshooting fundamentals.</p> <p>This could be used in an advanced vocational school, but is best suited for a community college or school program that is trying to grow from the operator level training and begin teaching troubleshooting and integration.</p>	<p>Level 3</p> <p>This coursework will train system integration in areas for robotics, PLC, process engineering, controls architecture, and machine design.</p> <p>This is perfect for an advanced technical school training students to apply theoretical knowledge of industrial systems, or a university that is looking to teach engineering and integration of industrial components and equipment.</p>
<p> - Training Certificate upon successful completion of e-learning.</p> <p> - Recognized industry certification issued by an independent credentialing authority.</p>		
<p>*iCC must be integrated with CERT cart, MTEC, or MTEC-SIM to teach robotics courses</p> <p>**Must purchase vision options in order to teach FANUC iRVision</p> <p>^C - Weld CERT Carts and MTECs with CRX robots are eligible for marked certificates only.</p>		

Learning Level	Career Path	Description	Cert. Type	ROBO-DRILL	CERT Cart	MTEC-SIM	MTEC	Weld CERT Cart	iCC (PLC/HMI)	AM-CERT	CSM	iIM5.0	
Level 2	FANUC Robot Technician	F FANUC: iRVision 2D			✓**	✓**	✓**	✓**		✓	✓	✓	
		F FANUC: Advanced TPP			✓	✓	✓	✓		✓	✓	✓	
		F FANUC: DCS			✓	✓	✓	✓		✓	✓	✓	
		I FANUC Certification administered by NOCTI: FCR-T1			✓	✓	✓	✓		✓	✓	✓	
	CNC Machine Technician	C FANUC CNC Concepts: FANUC Simulator Exercises					✓					✓	
		I NIMS Certification: CNC Mill Operations						✓ ^C				✓	
	Robotic Welding Technician	M Miller OpenBook: Applied Knowledge - Robotic Welding Labs							✓ ^C				
		I American Welding Society: CRAW Certification							✓ ^C				
	Maintenance Technician	C TRBD40-501 - Understanding the FANUC ROBODRILL			✓			✓				✓	
		C TRCNC40-501 - FANUC ROBODRILL Usage & Maintenance			✓			✓				✓	
		R Rockwell CCP153: Maintenance and Troubleshooting								✓	✓	✓	✓
		A Intermediate Concepts: Maintenance and Troubleshooting of Industrial Equipment							✓	✓	✓	✓	✓
		A Introduction to Industrial Automation and Integration						✓	✓		✓	✓	✓
		R Rockwell CCP 151: Basic Ladder Logic Programming								✓	✓	✓	✓
		R Rockwell CCP 143: Ladder Logic Project Development								✓	✓	✓	✓
		R Rockwell CCV 204-A: FactoryTalk View ME & PanelView Plus Programming								✓	✓	✓	✓
R Rockwell INA 201: Industrial Network Architecture Foundation									✓	✓	✓	✓	
R Rockwell INA 202: Industrial Network Architecture Intermediate									✓	✓	✓	✓	
PLC / Controls Technician	R Rockwell CCP 251: Advanced Logix 5000 Programmer								✓	✓	✓	✓	
	R Rockwell CCP 154: Studio Logix Designer Level 4 ST & SFC								✓	✓	✓	✓	
	R Rockwell SAF LOG 104: Guard Logix (and Banner) Application Development								✓*	✓	✓	✓	
	A Basic Integration Labs: PLC, HMI, Robot, Ancillary Components						✓	✓	✓	✓*	✓	✓	
	A Introduction to Safety Systems								✓*	✓	✓	✓	
	R Rockwell CCA 185: PowerFlex 525 Drive Startup and Configuration								✓*		✓		
	Robot Integration	A Robot to CNC: Integration Fundamentals and Labs			✓			✓	✓			✓	
		R Rockwell INA 203: Industrial Network Architecture Advanced Part 1								✓*		✓	
		R Rockwell INA 204: Industrial Network Architecture Advanced Part 2								✓*		✓	
		R Rockwell CCN 130: Motion Control Fund								✓*		✓	
Industrial Controls Integrator	R Rockwell CCN 144: Studio 5000 Logix Designer Level 4: Kinetix 5500/6500 (CIP) Programming								✓*		✓		
	A Safety Systems, Standards Design, and Application						✓	✓	✓		✓	✓	
	Applied Engineering of Robotics, Automation, and Industrial Systems	A Integration: Part Traceability								✓*		✓	
		A Integration: I/O Link Technology								✓*		✓	
		A Integration: RFID Technology								✓*		✓	
		A Integration: Advanced Integration of Industrial Equipment								✓		✓	
		A Integration: Advanced Part Tracking and Messaging								✓		✓	
		A Integration: Industrial 4.0 and IIoT								✓		✓	
I FANUC - Rockwell Level 3 Systems Integrator Certification											✓		

Advantages of Our Industrial Training Equipment

INDUSTRIAL TRAINING CLASSROOM

	OUR TRAINERS	OTHER TRAINERS
Trainers built for manufacturing training	✓	✓
Equipment built with exact same standards as industrial equipment	✓	
Curriculum with labs to apply knowledge	✓	✓
Curriculum comes directly from manufacturer; not rewritten	✓	
Labs are derived from industry practices, like live panel building utilizing industry standard wiring practices	✓	
Certificates upon completion of classwork or modules	✓	✓
Certifications directly from industry leaders like FANUC, Rockwell, and Miller Welding that carry over to the first day on the job	✓	
Rockwell MicroLogix basic PLC	✓	✓
Rockwell CompactLogix advanced PLC integration with Studio 5000	✓	
Advanced courses in FANUC TPP, iRVision, Advanced TPP, DCS	✓	
Advanced courses in integration of area scan, RFID, wireless I/O	✓	

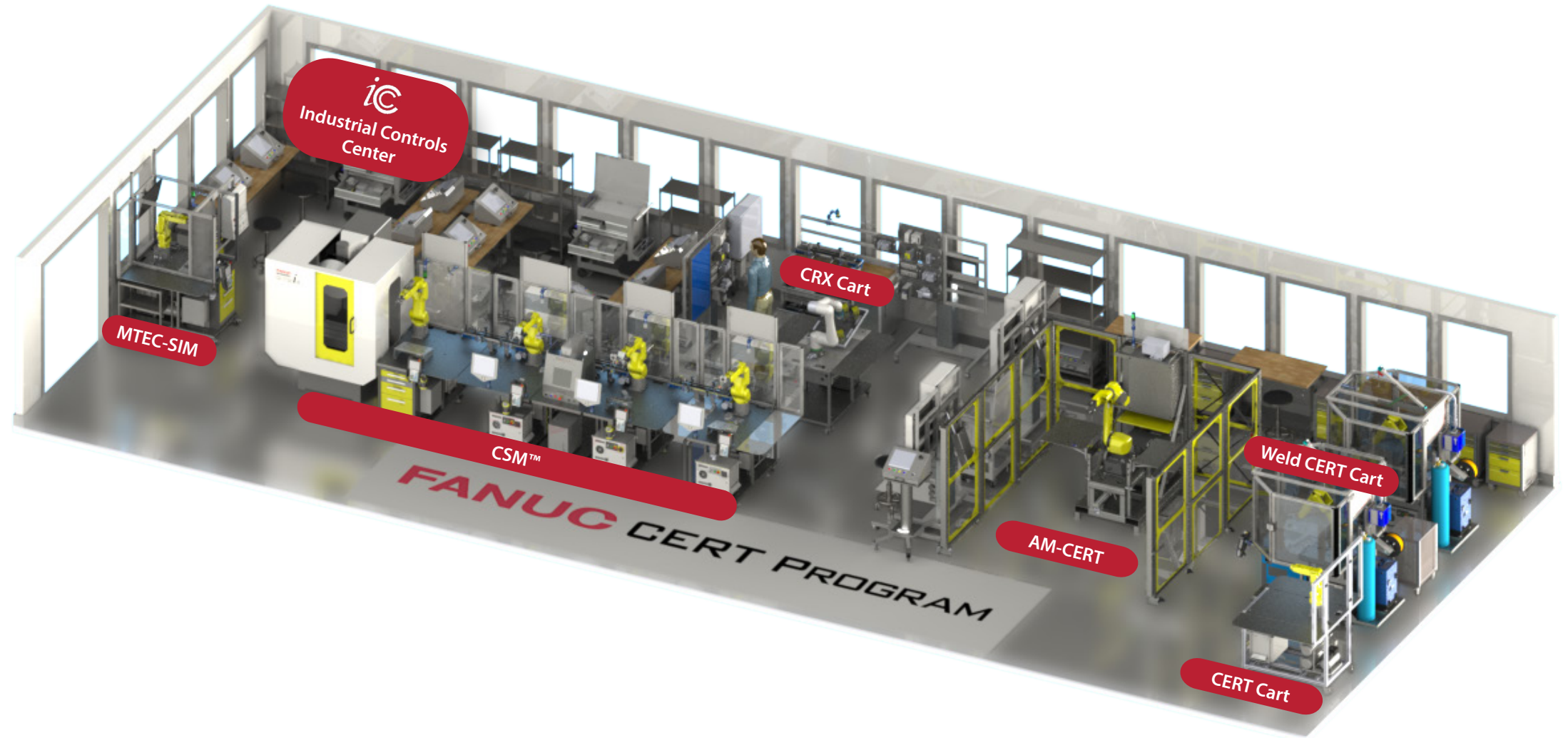

WE BELIEVE IN EDUCATION....

APT Manufacturing Solutions is an automated equipment builder and precision machine shop equipped with over 30 manual and CNC machines, laser cutting and fabrication equipment, mechanical engineering with 3D solid modeling, and controls engineering with PLC and robot programming. At APT, education and training is weaved into the core of our every move. We recognized years ago that educating the next generation is vital to our success, and the success of manufacturing in America, we have made it one of our primary strategic objectives.

“Our passion is to equip and teach the next generation of workforce to advance manufacturing, technology, innovation, and leadership.”

High School Training: Years ago, we founded a state-of-the-art high school training center where we opened our doors to high school students from surrounding schools to learn the nuts and bolts of manufacturing. We lead them through coursework and hands-on learning designed to open their eyes to the opportunities they have in industry after school. Courses include:

- OSHA safety 10 hour
- Tools of the trade
- Drafting and 3D Modeling
- Machining
- Welding and Fabrication
- Industrial Wiring and Panel Building
- Basic PLC logic and Control Systems
- Robot handling and programming

Apprenticeship Program: Students who graduate from these programs must enroll in apprenticeship program to continue employment, where they go through a two- or four-year program, fully paid, working during the day and continuing school at a community college at night. This has proven to be a phenomenal approach to education, developed over time based on need for workforce development. The key to this is the partnership that has come between industry and education. We believe this partnership is vital to changing industry and solving the workforce development problem as America moves forward.

“We don’t build education trainers...we build industrial equipment with industrial curriculum for the education market.”

It was through our passion for education that APT became a FANUC Education Solutions Provider, and this equipment is sold exclusively through the FANUC Education Solutions Provider Network. They carry the industry training curriculum of key manufacturers like FANUC America, Rockwell Automation, and Miller Welding. These partnerships are critical to maintaining high-caliber trainers that model industry standards.



FANUC Recommended Training Curriculum Path

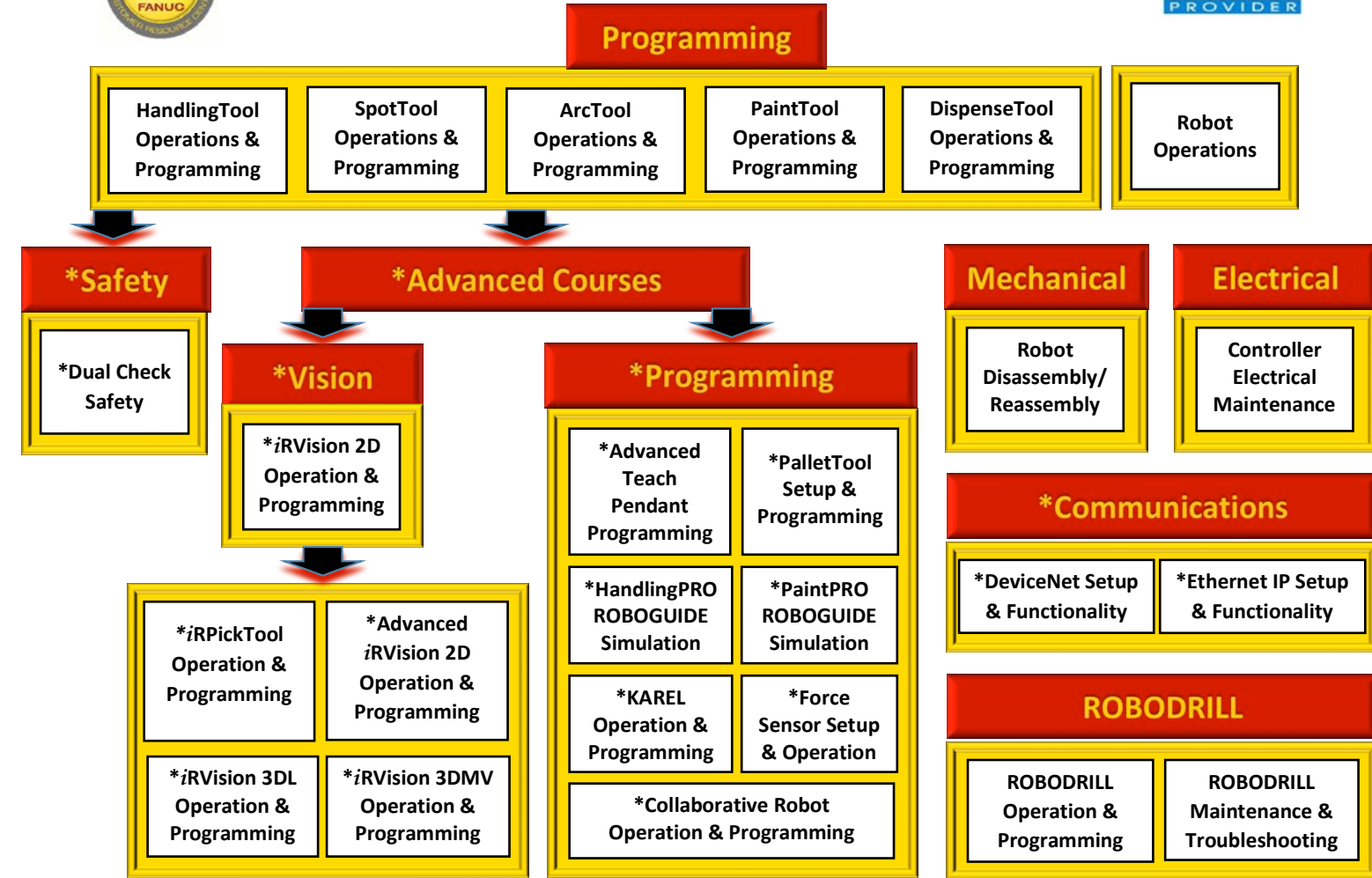

Please note: All courses marked * require completion of all prerequisites. Please view prerequisite requirements within individual course descriptions.



STAND-ALONE PRODUCTS FOR YOUR CLASSROOM

CERT CART

FANUC's CERT Cart is an entry level cart that teaches students basic tool handling skills as well as iRVision Pick and Place.

Instructors benefit from both FANUC's online and instructor led training, which are the same skills taught at the FANUC Robotics training facility. As an educator attending training, you'll be sitting beside industry programmers and learning the same course material that is being used in industry to apply in your classroom.

This is real world equipment, not a watered-down version. FANUC America provides this training opportunity to instructors as part of its CERT program allowing the industrial certification to be passed on to students.

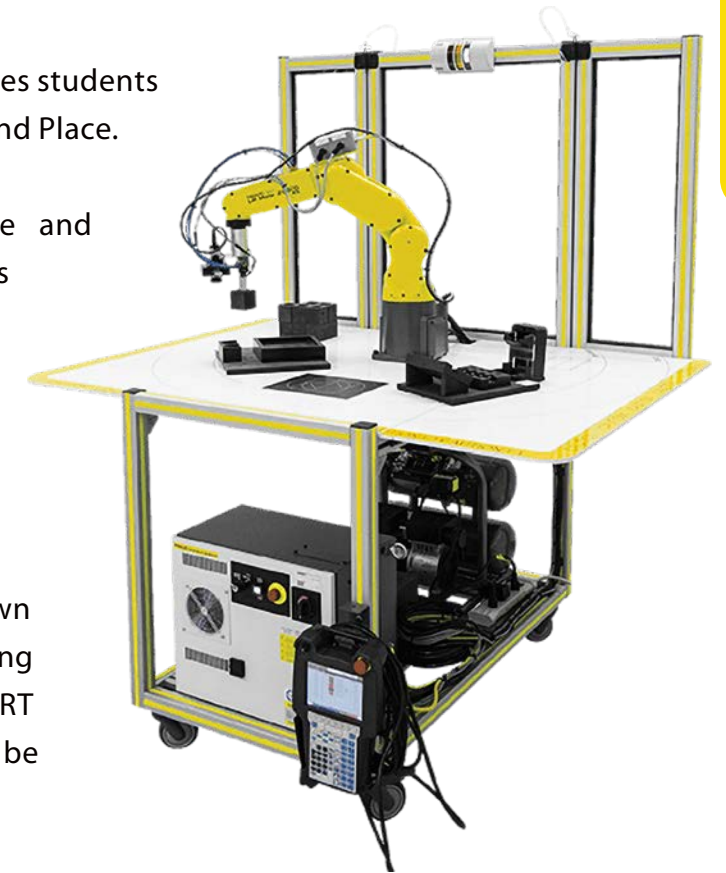

CRX-10iA/L



M-1iA



SCARA SR-3iA



iCC PLC/HMI



CNC Simulator Controller



Collaborative CR-7



LR Mate 200iD-7L



ROBODRILL CNC

PROJECT-BASED LEARNING (PBL) KITS

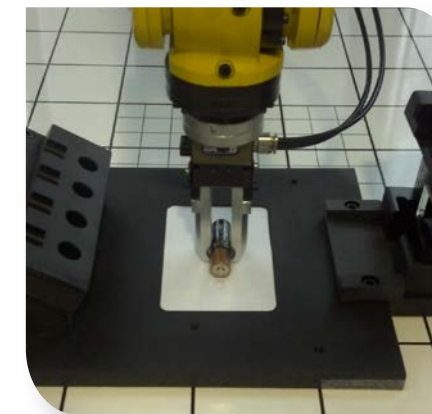

Battery Package



Pill Kit



I/O Simulation Box

All FANUC robots are available. Contact your education solutions provider.
Also see accessories on next pages.

FANUC ROBODRILL CNC

Industry-Rated, Priced for Education

The Fanuc ROBODRILL is a high-performance machining center, known worldwide as the most reliable machine manufactured today. ROBODRILLS make quick work out of any milling, drilling or tapping jobs. Reliability has also been addressed in all areas of the machine design. Coupled with the latest Fanuc 31i-B control, the ROBODRILL is the preferred machine in any manufacturing facility large or small.



ROBODRILL 3-axis

- FANUC ROBODRILL α-D14MiB series
- NRTL for ROBODRILL MiB5/LiB5 without breaker box (ONLY NRTL)
- 31iB/B5 - Additional 1 slot board
- Touch panel screen
- Right side auto pneumatic door
- Robot interface 2 for side door (CNC with built-in multi-function Ethernet type) or without hub (with robot interface creen), includes 3-76 FL-net, robot connection function and safety function by FL-net
- Side window and basic top cover of splashguard
- Automatic oil lubricating (standard)
- Illumination (standard)
- Coolant unit with chip flush - tank capacity 100L
- Outer coolant piping
- Fast data server (with compact flash memory 4GB)

ROBODRILL 5-axis

- Available with custom order

ROBODRILL ECO 3-axis

- FANUC ROBODRILL α-D14MiB series
- NRTL for ROBODRILL MiB5/LiB5without breaker box (ONLY NRTL)
- No coolant tank included
- Part program storage size 2Mbyte
- Ethernet function

Add an optional Industrial or Cobot robot tender to ROBODRILL 3-axis or 5-axis (Not available for ECO 3-axis)



ROBODRILL Accessories

Tooling Package

- BT30 tool holder tightening fixture
- ER20 wrench
- (10) Retention knob
- (10) BT30 ER20 Collet holder
- ER20 21-piece collet set
- 1/2" carbide endmill
- 3/8" carbide endmill
- 1/4" carbide endmill
- 1/8" chamfer mill
- Edge finder

Vise Kit

- 4" Vise
- 4" Handle
- 4" Aluminum jaws
- (2) 3/8 tee nuts
- (2) Hold down bolts

Other Accessories

- 5 gallon TRIM MicroSol 585XT coolant
- Brix refractometer coolant testing
- Vactra No. 2 way oil, 5 gallon pail
- 0.25 GPH 8" reach belt oil skimmer
- 4" aluminum jaws

Project-Based Learning (PBL)

Clock



Business Card Holder



ROBOT MACHINE TENDER

MTEC - MACHINE TENDING EDUCATIONAL CELL

CNC

CNC



Shown with FANUC ROBODRILL D14MiB5 (sold separately)

- FANUC ROBODRILL Interface between robot and CNC for seamless integration
- 120 VAC power connection to MTEC
- Fits through 36" door (without ROBODRILL) and includes four side pick up and transport
- Optional iRVision 2D for error proofing and guidance
- Optional built-in toolbox for convenience

- Students familiar with CNC and/or robots have the opportunity to learn real world advanced automation integration
- Fenceless or fully-guarded safe work envelope
- Preconfigured with load and unload program templates for simple build with no complex programming needed
- Drawer load for blank parts is safe and can be configured for other parts in the future



Optional machine tender CRX on mobile base (not eligible for CERT program)



Optional machine tender CRX on mobile cart (not eligible for CERT program)



- Fold-up work table for laptop, textbook, etc.
- Safety area scanner for fenceless robot operation or safety interlocked access door to robot work area
- 3-color beacon operation indicator light
- Swivel casters with brakes and rotation lock
- Part locating template for NIMS mill block or dual conveyor in/out for parts blanks
- Single 2-jaw EOAT for NIMS mill block (3/4" x 2 1/2" x 3 1/2" aluminum, 50 pcs included)



FANUC LR Mate 200iD/7L long-arm 6-axis robot

- R30iB Plus robot controller
- 2D iRVision optional

CRX-10iA/L long-arm 6-axis robot

- R30iB Plus Mini robot controller



- Standard CNC D14Mi-B5
- Smart Trouble Shooting Function
- Memory card slot plus USB port
- Built-in interlock function for safety
- Enables robot operation and system status display on the robot operation screen
- Custom PMC to create, read, and write ladder programs



ROBOT WITH CNC SIMULATOR

MTEC-SIM - MACHINE TENDING EDUCATIONAL CELL



- FANUC ROBODRILL Interface between robot and CNC simulator for integration training
- 120 VAC power connection to MTEC-SIM with on-board air compressor for self-contained cell operation
- Fits through 36" door
- Optional *iR*Vision 2D for error proofing and guidance
- Built-in toolbox for storage

- Students have the opportunity to learn real world advanced automation integration
- Preconfigured with load and unload program templates for simple build with no complex programming needed
- 3-axis mill and 2-axis lathe simulation

MTEC-SIM Features



- Modular robot cart
- Welded steel construction
- Fits through standard doorway
- Single 2-jaw EOAT for mill blank and lathe blank
- Fold-up work table for laptop, textbook, etc.
- Safety area scanner for fenceless robot operation or safety interlocked guarding around robot work area
- 3-color beacon operation indicator light
- Swivel casters with brakes and rotation lock

FANUC ROBOTICS

FANUC LRMate ER4*i*A 6-axis robot

- R30*i*B Plus robot controller
- 2D *iR*Vision optional

FANUC's new R30*i*B Plus robot controllers feature the new *i*Pendant with enhanced screen resolution and processing capability.

The new user interface, *i*HMI, can display guides for setup and programming, as well as tutorials from the main home page which as a design common to FANUC CNCs, enabling easier use of robots.

FANUC CNC

FANUC's CNC simulator is designed specifically for educational purposes, ensuring affordable access to the latest FANUC CNC platform in a compact and portable package, easily integrated into any classroom.

- Switchable mill and lathe system in one simulator
- 3-axis milling / 2-axis turning system + 1 spindle
- Conversational programming and 3D simulation (MGi)
- Inch / metric switchable
- 32 tool offset pairs
- Work piece coordinators G52-G59 + 48 additional on mill



PLC/HMI TRAINER

Rockwell Automation (Allen Bradley) CompactLogix control panel electrical project kit



Featuring
Rockwell's latest
Products and
Technology

- Rockwell CompactLogix 5380 controller with Integrated Motion (5069-L306ERM) with 16 24VDC digital inputs & 16 24VDC digital outputs
- Rockwell AB 10" PanelView 5000 Graphic Terminal (PanelView 5310)
- 5 Port Stratix Ethernet Switch
- Dual Ethernet Access Ports and Cable Glands for external device connections
- Pre-loaded with structured program template
- Also sold in kit form along with Rockwell curriculum
- Endless possibilities - can connect to almost any device!
- PLC robot integration program template installed

Includes 1-year
subscription to
Rockwell software

PLC/HMI Trainer
ready to use as
standalone OR integrate
to any FANUC robot



Ready to interface with your
FANUC CERT robot over Ethernet IP
protocol or optional discrete I/O

Ask about your custom needs.
Prices may vary.

INCLUDES:

- NEMA 12 steel industrial enclosure
- 120V, 24 VCD power supply
- 120V 10' power cord
- 5 port ethernet switch
- Wireless ethernet bolt
- 4 pushbuttons
- 1 selector switch

PLC: Compact Logix 5000 Series

- 32 task
- Dual IP mode (2 diff network connections)
- DLR, star and linear topologies supported
- 16 ethernet node connections max
- 32 socket connections max
- 2 CIP drive axis connections (position loop/servo control)
- Ladder structured text, function block diagram
- Sequential function chart programming interfaces
- 0.6 MB user memory
- 8 local I/O Modules max

HMI: Panelview 5000

- 10.4" SVGA TFT color touch display
- 4:3 aspect ratio
- 800 x 600 pixel resolution
- 1GB RAM / 1 GB user memory



OPTIONS:

- » Student build kit
- » Discrete I/O kit to FANUC LR Mate peripheral I/O board for robots without ethernet
- » Mobile workbench - adjustable height with power
- » Replenishment parts kit
- » Panel rebuild master kit

MECHATRONICS CERT CART

iIM5.0 - INDUSTRIAL INTEGRATED MECHATRONICS TRAINER

FEATURES:

- FANUC LR Mate ER4iA 6-axis robot
- Brushless DC motor and drive
- Power transmission via belt drive
- Conveyor part transport
- Fluid power (pneumatics)
 - Direction control valves
- Rotary actuator
- Escapement actuator
- Guided linear actuator
- Sensor technology
 - Optic
 - Laser
 - Solid state hall effect
 - Proximity
 - Inspection
- *Optional iCC PLC/HMI trainer*

Shown
with optional
iCC PLC/HMI
trainer

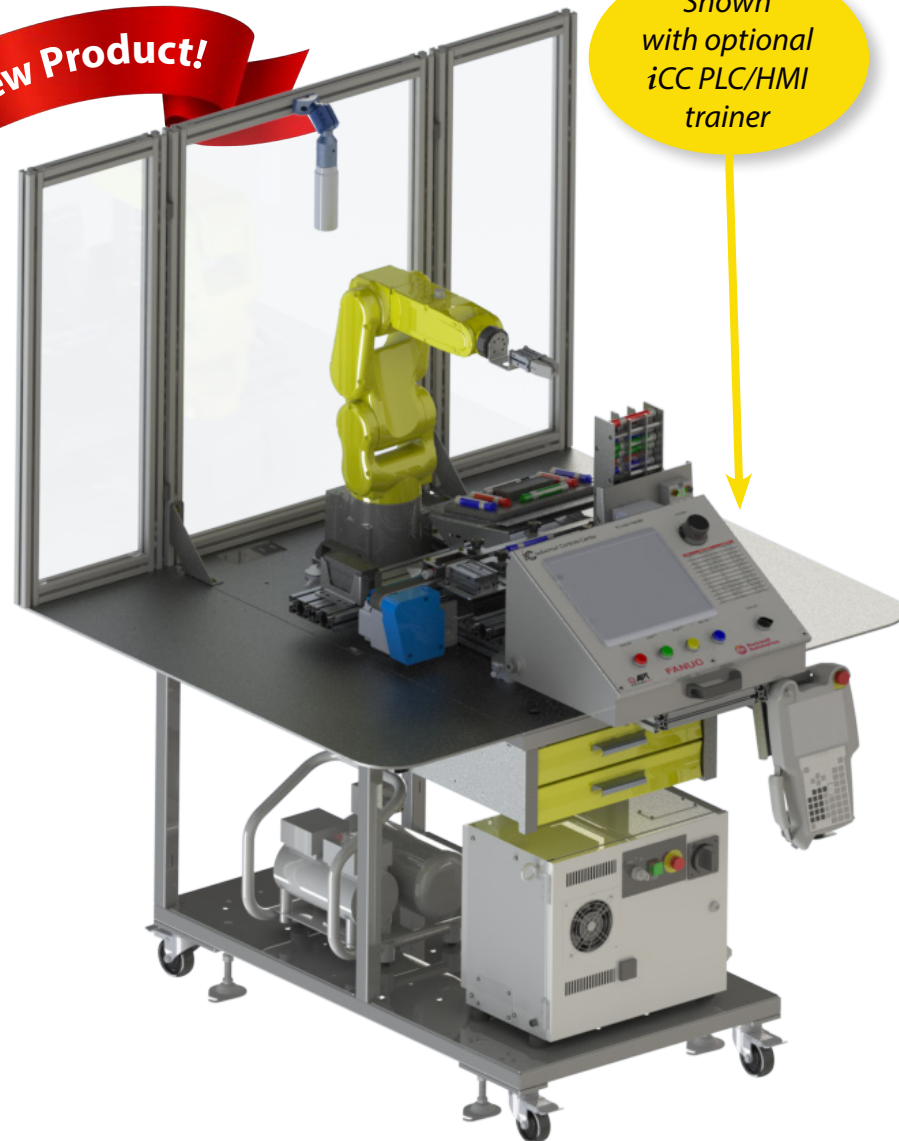

*Industry 5.0 is the next step in the industrial revolution:
People, robots, and smart machines working together.*

iIM5.0 Features



- Fold-up work table for laptop, textbook, etc.
- Safety area scanner for fenceless robot operation
- 3-color beacon operation indicator light
- Swivel casters with brakes and rotation lock
- Dry-erase marker PBL
- On-board air compressor
- Plugs into 20 amp 120vac power

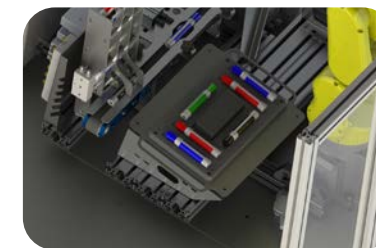

PBL (Project-based Learning)

- Product manufacturing with sortation and package assembly
- Bulk material infeed
- Color Sortation
- Robotic packaging/assembly

FANUC

- FANUC LR Mate ER4iA 6-axis robot
- FANUC R30iB Plus robot controller
- 2D iRVision optional

FANUC's new R30iB Plus robot controllers feature the new iPendant with enhanced screen resolution and processing capability.

The new user interface, iHMI, can display guides for setup and programming, as well as tutorials from the main home page which as a design common to FANUC CNCs, enabling easier use of robots.



(Included with optional
iCC PLC/HMI trainer)

- NEMA 12 steel industrial enclosure
- 120V, 24 VCD power supply
- 5 port ethernet switch
- Wireless ethernet bolt

PLC: Compact Logix 5000 Series

- Dual IP mode (2 diff network connections)
- DLR, start and linear topologies supported
- 16 ethernet node connections max
- 32 socket connections max
- 2 CIP drive axis connections
- Ladder structured text, function block diagram
- Sequential function chart programming interfaces
- 8 local I/O Modules max

HMI: Panelview 5000

- 10.4" SVGA TFT color touch display



INDUSTRIAL MATERIAL HANDLING TRAINER

AM-CERT - ADVANCED MANUFACTURING CERT CELL

Train on Industrial Equipment for Advanced Manufacturing
Take your training to the next level!

Fully integrated Rockwell PLC with FANUC robot for advanced material handling

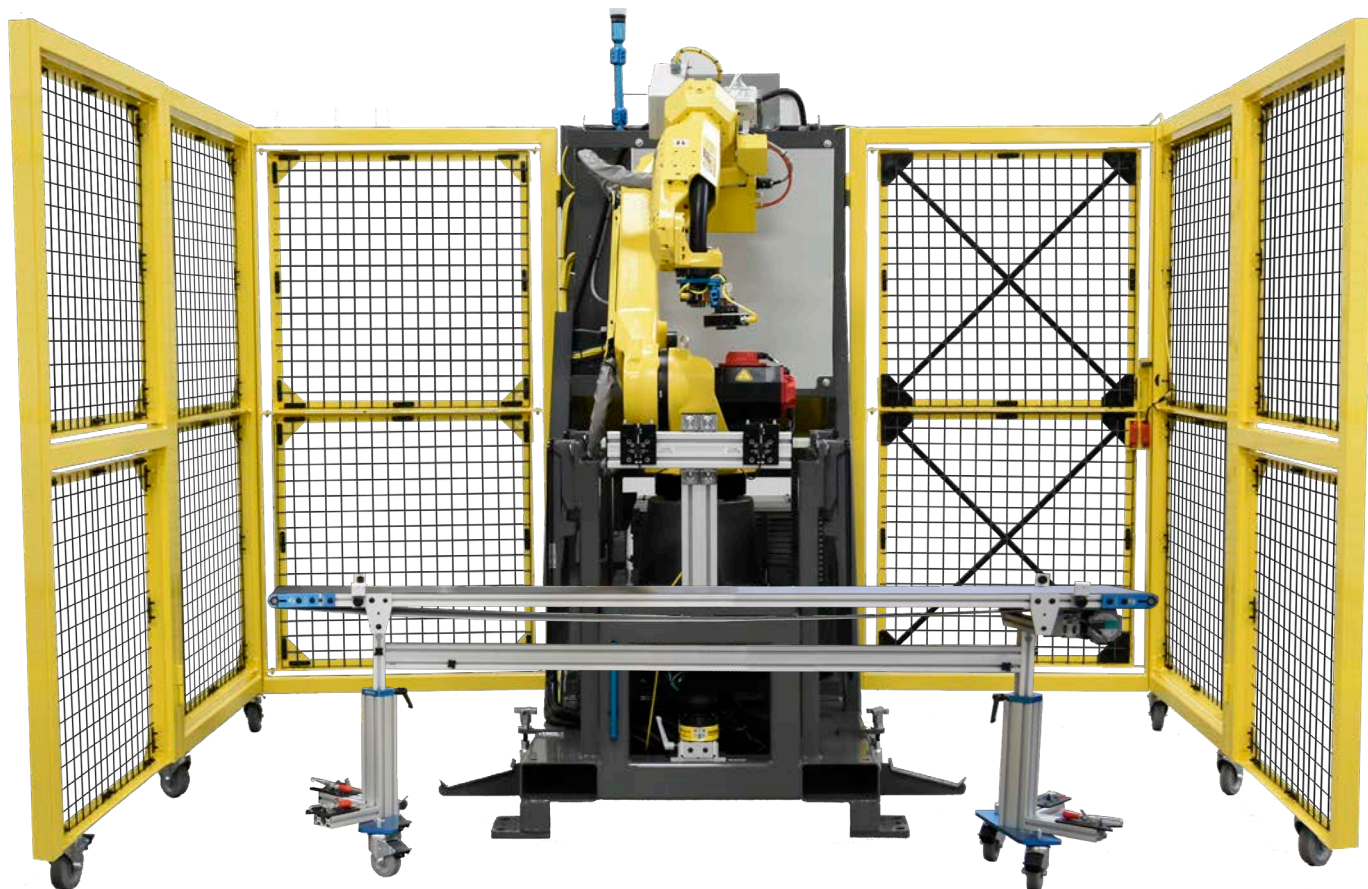

Product Dimensions:

Open: 10' deep x 10' wide x 88" high

Folded: 72" deep x 54" Wide x 88" high

Rockwell PLC • FANUC Robot • FANUC iRVision • Swivellink® Conveyor

Robotics • PLC • Safety • Pneumatics • I/O • Vision

AM-CERT Features



- Folding perimeter fencing
- Access panel for conveyor through the perimeter fence
- Slide out programming laptop desk with 110 VAC power supply
- Fold down pick and place tables
- SMC pneumatics, filter/regulator
- SMC valve bank wired to robot I/O
- SMC two-jaw robot gripper with open/close sensors and Piab vacuum with vacuum switch
- Available ATI automatic tool change with separate gripper and vacuum tool
- Portable with pallet jack or forklift

FANUC

- FANUC M10iD or M20iA 6-axis robot
- FANUC R30iB Plus robot controller
- 2D iRVision

FANUC's new R30iB Plus robot controllers feature the new iPendant with enhanced screen resolution and processing capability.

The new user interface, iHMI, can display guides for setup and programming, as well as tutorials from the main home page which is a design common to FANUC CNCs, enabling easier use of robots.



- Safety interlocked entry door
- 16 remote accessible configurable I/O points
- PLC control panel with viewing window, main power disconnect, program access port on outside of panel
- Rockwell CompactLogix™ or Compact GuardLogix® PLC cell control
- Rockwell PanelView™ 10" touch screen interface with cell function screens
- Light curtain or area scan safety for robot work area
- Main power choice of 208 VAC 3 phase, 220 VAC 3 phase, or 480 VAC 3 phase

Product Options:

AM-CERT-10	Material Handling CERT Cell with M10 Robot
AM-CERT-20	Material Handling CERT Cell with M20 Robot
Option 1	Swivellink® Conveyor
Option 2	Area Scanner 270° Protection
Option 3	Automatic Tool Change
Option 4	Safety PLC Option
Option 5	Transformer 208V, 220V, or 240V 3-Phase Power



Shown collapsed

SMART MANUFACTURING TRAINING SYSTEM

CSM™ - CONNECTED SMART MANUFACTURING



Shown with ROBOTDRILL CNC

FANUC CNC Controls

FANUC Industrial Robot

CSM FEATURES	FANUC CNC Controls			FANUC Industrial Robot			
	CNC Simulator Or iF Plus Controls	Levil CNC LMV-400 Or iF Controls	ROBOTDRILL CNC α-D14M/B5 FANUC 31-B5	OP10 Machine Tender	OP20 Laser Part Marking	OP30 Assembly Station	OP40 Packaging Station
Pricing	\$	\$\$	\$\$\$	\$	\$\$\$	\$\$	\$\$
Integrated industrial production line	✓	✓	✓	✓	✓	✓	✓
Production line flow	Right	Left	Right	Follows CNC flow	Follows CNC flow	Follows CNC flow	Follows CNC flow
Industry 4.0	✓	✓	✓	✓	✓	✓	✓
Project-based mechatronics					✓	✓	✓
FANUC Certification	✓	✓	✓	✓	✓	✓	
FANUC CNC controls	✓	✓	✓				
Machine actual parts		✓	✓				
CNC tool holder type		S20T ER-16	BT-30				
Coolant		✓	✓				
Spindle RPM		14000	10000				
FANUC robot machine tender	✓	✓	✓				
FANUC iRVision	✓			✓	✓	✓	✓
Vision-guided pick and sort						✓	✓
Vision inspection				✓	✓	✓	✓
Fenceless robot cells with safety area scan				✓	✓	✓	✓
Rockwell Studio 5000 Logix PLC					Slave	Master	Slave
Rockwell Safety PLC				✓	✓	✓	✓
Rockwell HMI PanelView™ touchscreens					✓	✓	✓
Rockwell e-learning subscription					✓	✓	✓
Fluid power pneumatics				✓	✓	✓	✓
Part traceability and marking					✓		
Modular work cells (can be used independently)	✓	✓	✓	**	✓	✓	✓
Portable (fits in classroom)	✓	✓		✓	✓	✓	✓
Wired or wireless between stations				✓	✓	✓	✓
Fault insertion				✓	✓	✓	✓
Smart sensor technology I/O link with diagnostics					✓	✓	✓
Dual robot end-of-arm tool vacuum/mechanical grip				✓	✓	✓	✓
Conveyors with VFD (variable speed drives)					✓	✓	✓
RFID manufacturing process tracking					✓	✓	✓
APT integration curriculum	✓	✓	✓	✓	✓	✓	✓
120V 20 amp	✓	✓		✓	✓	✓	✓



**The OP10 cannot be separated from the CNC once mated through the controls

BUY INDIVIDUALLY OR AS A COMPLETE SYSTEM



This system is truly like no other Industrial System for Education Institutions.

Your students will use FANUC/Rockwell products on a factory system to understand a fully integrated line. Each cart can also be detached for individual learning.

Integration from:

FANUC CNC Machine Making Product

OP10 Machine Tending the CNC

OP20 Laser Marking the product

OP30 Assembly of the product

OP40 Packaging the product in boxes



- FANUC LR Mate 200iD 4S 6-axis robot
- 2D iRVision Optional

FANUC's new robot controllers feature the new *i*Pendant with enhanced screen resolution and processing capability. The new user interface, *i*HMI, can display guides for setup and programming, as well as tutorials from the main home page which has a design common to FANUC CNCs, enabling easier use of robots.

Using the programming guide, even first-time robot users can create a program for a simple handling task and execute it in just 30 minutes! Easier usage also improves efficiency by facilitating system setup and maintenance.



CONNECTING SMART MANUFACTURING

High-Performance Vertical Machining Center α-D14MiB(5)

The ultimate all-round vertical machining center Model M, perfect for milling and drilling tasks requiring maximum precision, versatility and reliability.

- Optimal acceleration and deceleration control
- Rigid Design
- Easy maintenance and operation
- Extremely Fast .9 second tool change
- High Precision Control
- Designed for easy automation



- Rockwell CompactLogix or GuardLogix PLC cell control
- Rockwell PanelView 10" touch screen interface with cell function screens
- Safety interlocked entry door
- 16 remote accessible configurable I/O points
- 3 color beacon light
- Main power disconnects
- Program access port on outside of panel
- Area scan safety for robot work area



CONTROLS INTEGRATION

Controls integration is the key to connected systems, IIoT, and industry 4.0. In order to continue to advance in manufacturing technology, we must continue to train connected systems, hardware and software, and integration of control systems.

APT equipment is designed specifically to teach advanced electrical hardware, software development, and integration of control systems. We are using the same equipment and software that is being used in the majority of industrial equipment; not what is cheapest or has free software. We are using the latest technology and hardware.

We have partnered with FANUC America to offer EDU grants and Rockwell Automation to provide Learning+, where applicable, to schools who want to get involved on this advanced manufacturing training.

APT provides all programs, drawings, templates, and design documentation unlocked and free of charge. The school has access to every part of the controls system and access to any passwords and security setup within the equipment to develop and teach curriculum that best suits the industry in their region. Our sample programs and templates have been developed by observing and taking the best programming methods observed over 25 years of industry practice. The HMI interface and PLC code and structure focus on simple core programming methods that make operating, maintaining, and troubleshooting easy to perform. Our hope is that this focus on ease of use and simple programming gets distributed through all students that learn on our equipment.

Our design allows for students and instructors to have fully functional industrial grade safety systems that allow the system to run at greater speeds than typical education system should be allowed to run. The safety systems also allow for students and instructors to work closely with the equipment and remain safe. Our fenceless versions of equipment allow personnel to approach the equipment and the equipment will slow down or stop accordingly and then resume once it is safe.

AN IN-DEPTH LOOK AT THE OPERATOR INTERFACE

The HMI is broken into 5 color coded tabs with enhanced diagnostics on the system. 3D graphics are put on the different screens just as we would in the industry.

SYSTEM - These screens are used for general machine setup. A majority of the functions available on the systems require security requirements to access them. Several functions on the System HMI screens include: VFD frequency setup; Recipe Management System, Inspection Limits, I/O Link Setup, Login, and System Security Settings.



OPERATIONS - These screens are used for general machine operation and functionality. 3D model images are used to aid with the intuitiveness and ease of use. Status Indicators, Mode Control, and Manual Operations, along with Operational and Fault Messages are displayed on these screens.



ROBOT - This screen displays all communication and I/O interface between the system PLC and robot. Users may also manually control the functions of the robot and call a specific robot program to run from this screen.



I/O - On this screen users can see all I/O within the system, its present status on/off to run diagnostics and aid in troubleshooting.



PRODUCTION - From these screens the user can view and capture production data to be used for business analytics. Recipe management and the production scheduler allow the users to edit the parameters and schedule all products the system can run.



ROBOTIC WELDING TRAINER

ArcMate Cart Features:

- Tinted sides to protect classroom (helmet required for viewing)
- FANUC Arc Mate 50iD/7L
- FANUC R30iB Mate plus controller
- Robot work area guarded for student safety

FANUC ARC CERT: (ArcMate Only)



- FANUC ARC CERT Gift in Kind Package for qualified schools (Ask education solutions provider for details)
- FANUC Advanced Academic Software/ARC Bundle
- FANUC ARCTool Student Certificate Program

CRX Cart Features:

- (not eligible for CERT program)
- FENCELESS (helmet required for viewing)
 - FANUC CRX 10iA
 - FANUC R30iB Plus Mini controller



Both versions include:

- Welded construction
- Fully integrated collapsible mobile cart design that fits through standard 36" door
- Miller Welding Power Supply Training Program (brand-specific; see program details)

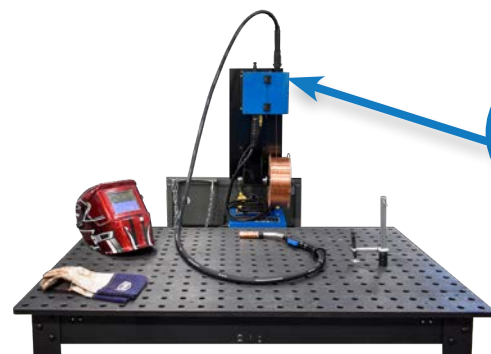

Plug the optional 15' handgun into the existing Miller power source to get 2 ways to weld!

Optional Miller all-in-one manual to robotic MIG wire weld gun designed for versatility and ease-of-use. Can be used with either cart's welding supply

Miller WELD CERT CART Features

Integrated Weld Educational Cart



Education & Software

OpenBook™

OpenBook™ is Miller's learning management software. It's designed to help you plan, offer, and assess student learning. It provides welding instructors, learners, and management with an easy tool to teach welding concepts and techniques to a variety of students - from those just starting out to professionals in the field who'd like to learn new skills or refresh their current techniques.



Insight Core™ (Standard)

Simplified, internet-based welding information solution that reports cell productivity and weld parameter verification.

- Provides basic production metrics such as amps, volts, wire feed speed, arc on time and arc on time percentage

Transform data into actionable information that drives continuous improvement.

Learn more at MillerWelds.com/insight

Features

Auto-Continuum™ Systems

Take your welding to the next level.

The adaptive arcs of Versa-Pulse™ and Accu-Pulse instantly make adjustments to handle weld tacks, large gaps and inconsistent parts. The result is higher quality welds and fewer weld defects.



Versa-Pulse™

- Fast, low-heat, low-spatter process
- Great for gap filling
- Shortest arc length/lowest pulse voltage

Accu-Pulse®

- The most popular process for majority of industrial welding applications
- Most adaptive arc on 16+ gauge
- Designed for all weld positions

RMD®

- Lowest heat process, best for gap handling
- Limited travel speed



Auto-Continuum 350
11,000 watts

More power, better reliability



• Easily add new processes and custom programs

• Parameter flexibility

Easy to add capabilities

Best for	Standard Spray	High-Deposition MIG	Accu-Pulse	Versa-Pulse	MIG Short Circuit	RMD
Deposition	A	A	A	B	D	D
Gap Filing	D	D	B	B	A	A
Low Heat Input	D	C	B	A	A	A
Out-of-Position Welds			A	B	B	B
Low Spatter	A	A	A	A	C	B
Thick Metals	A	A	A	C	D	D
Thin Metals			B	A	A	A
Increased Travel Speed	A	A	A	A	B	C

HOT COLD

Manufacturing Equipment



FILTAIR® 130

- High-efficiency filter designed to capture weld fume
- FilTek™ XL cleanable filters last longer
- Lightweight and portable
- Quieter for a safer, more productive work area

Included: Work Holding Kit (APT88001132)

6" x 1.5" x 6"



(1) Pivot Angle 150 Mini

3.6" x 1.7" x 3.4"



(1) Mini Multi Angle

2.3" x 1.3" x 2.1"



(1) Mini Angle

Optional: PPE Kit (APTWELDPPE)



Optional:

15' Industrial MIG Gun with 15' ground cable



10% Graduate Discount at Mag Tools
Use APTWELDCCELL at mag-tools.com

ROBOT ACCESSORIES

Mobile Cart



- 27 1/2" wide x 47 1/4" long
- Optional wings fold to fit through standard 36" door
- Out-of-the box solution for FANUC CRX as a mobile training system.



Add wings to expand work area to 57" wide x 47 1/4" long

Mobile Pedestal

Kit includes:

- 24" CRX pedestal
- Mobile base
- Controller bracket
- Teach tablet holder.
- Heavy duty welded steel construction
- Standard gray powder coated finish
- Total locking swivel and wheel brakes
- Industrial swivel leveling feet for stability
- Non-slip pads on each leveling foot
- Large footprint for stability



Parts Presentation Kit sold separately

Mobile Cart Optional Add-ons

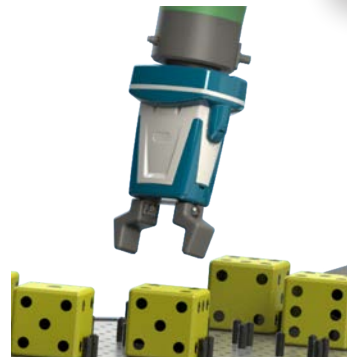

Robot End-of-Arm Tool

- Schunk CoAct collaborative EOAT
- Parallel gripper kit with 2 jaws for 3" blocks
- Ready to connect to FANUC CRX

Parts Presentation Kit with 3" Foam Dice Blocks

- Fixed grid, 12 location diamond template with six (6) 3" foam dice cubes
- Pegboard reconfigurable template with 50 locator pegs and six(6) 3" foam dice cubes



Pedestals

We stock pedestals for the CRX and LR Mate robots.

- Range from 24" to 48" tall in 6" increments
- Holes for leveling and anchoring
- Steel welded construction
- Powder coat finish

When mounting these robots we recommend guarding (see next page).

Always be safe when operating a robot.



CRX

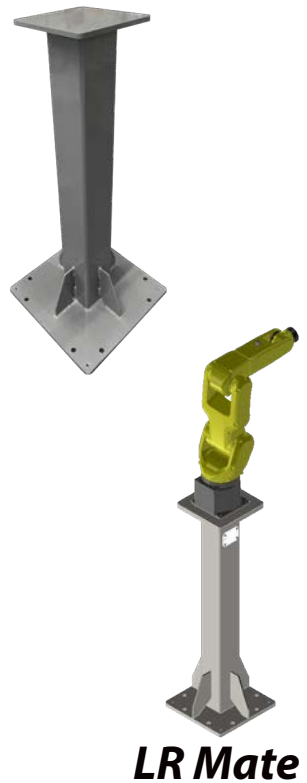

LR Mate

ROBOT ACCESSORIES

Swivellink® 4-1/2"W X 36"L Variable Speed Conveyor

- Swivellink® belt conveyor with variable speed capability (conveyor mounted speed control)
- 4-1/2" wide bed, 4-1/4" wide belt, 36" overall length conveyor
- Hard stop each end of conveyor
- Optical sensor at idle end of conveyor on adjustable mount
- Optical sensor at drive end of conveyor on adjustable mount
- Sensor cables and motor control forward / reverse terminated in small junction box
- 120 VAC Power cable



Free Standing Conveyor

- Free standing conveyor base with adjustable height stands
- Locking swivel casters for portability
- Adjustable side rails

Magnetically Mounted Tabletop Conveyor

- Conveyor base with switchable magnetic mounts
- Side rails, one side fixed, opposite side adjustable



Safety Fencing

Create a "Lab Environment Work Cell" for Robots

This is industrial guarding "STRONGUARD®" used in industry for perimeter guarding around robot cells. We offer this to education for students to safely run the robot and additional students see over the top of the guarding for instructional purposes. All the standard guarding is 53" tall for visibility, we offer a few kits that we feel would be best used for these robots:

- 5' x 5' for SCARA or FANUC LR Mate
- 7' x 7' for FANUC M10
- 10' x 10' for FANUC M20
- Additional sizes also available

The safety mesh is 2" x 2" black coated, the post and frames are made of steel and are powder coated Safety Yellow. We offer several safety options that include:

- Gated entry with latch and interlock switch.
- Light curtain, three-sided guarding with one open side.
- Area scanner kit with narrower side panels.



Ask about your custom needs. Prices may vary.

Wireless Expansion Remote I/O

Add a wireless network to your robot or other training equipment.

Configure with remote modules and untether!

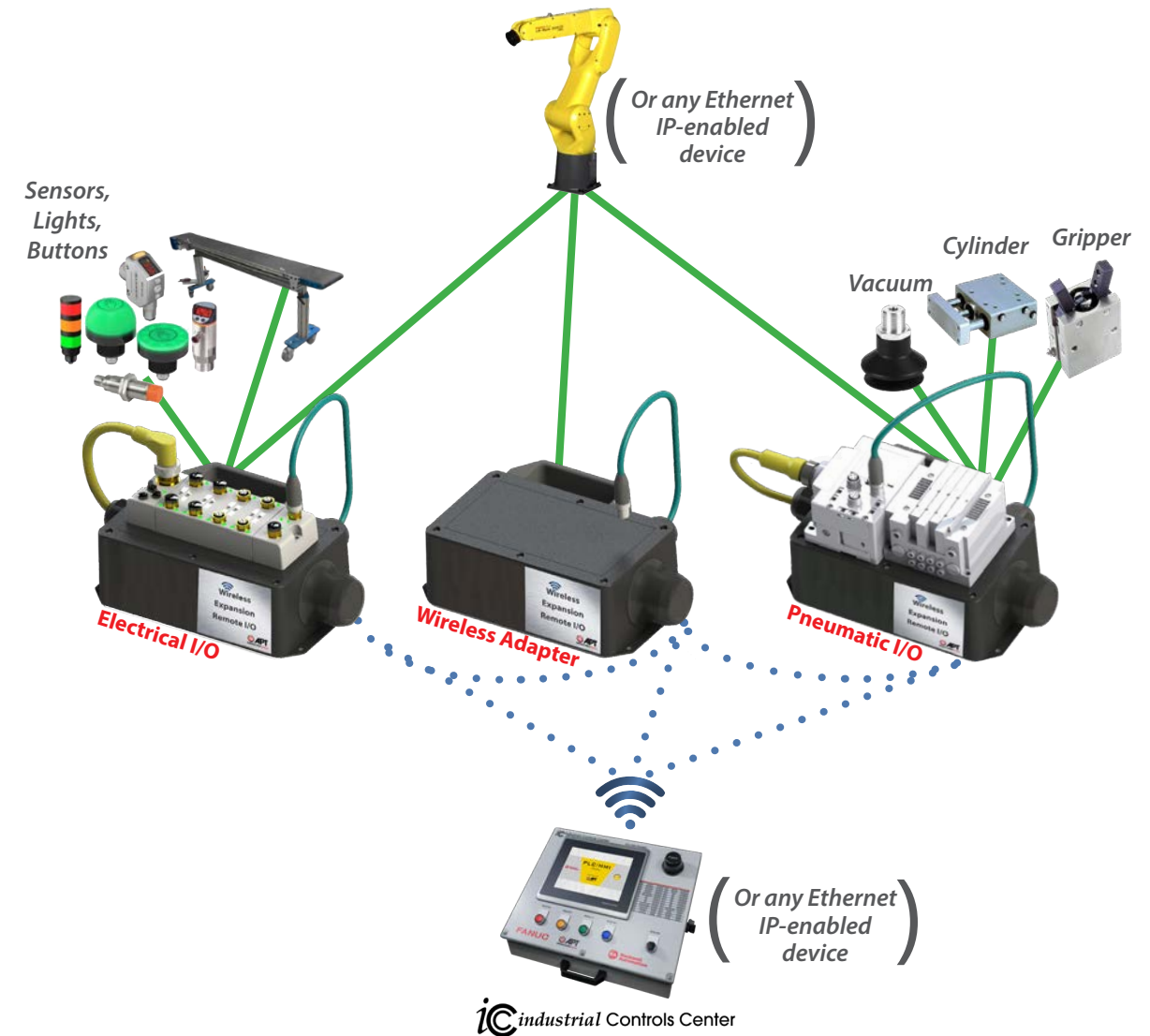

Wireless

- » WEP, WPA, and WPA2 security protocols
- » Anybus wireless bolt
- » Add network communication to your FANUC robot

Electrical

- » Configurable 16 points of input/output (using splitters on 8 access ports)
- » Industry standard M12 5-pin port

Pneumatic

- » Four individually controllable valves
 - ♦ Double solenoid, 2 position, blocked center ports
 - ♦ Double solenoid, 2 position, open center ports
 - ♦ Double solenoid, 2 position, detent
 - ♦ Single solenoid, 2 position, spring return
- » Great for testing and understanding fluid power
- » Use for temporary setups and testing or permanent installation
- » Valves are triggered over Ethernet

CLASSROOM DESIGN SERVICES

Let us design your classroom
with industry-recognized equipment and curriculum

APT's Design Team is comprised of field experts with years of experience.
Engineering • Automation • Management • Material Handling • Mechanical • Design

Our design team will talk to you to get an understanding of your initiatives and goals.

We will then design a classroom with automation and robotics equipment and curriculum to make your students a valuable candidate to employers.

We will align education solutions with your budget requirements, with consideration for local industry reliability, software licensing requirements and maintenance costs.

Considerations

- Long-term plan
- Variety of learning options
- Environmental and lighting requirements
- Utility requirements and locations
- Enough space for equipment and collaboration
- Plan for future growth
- Understanding local industry needs

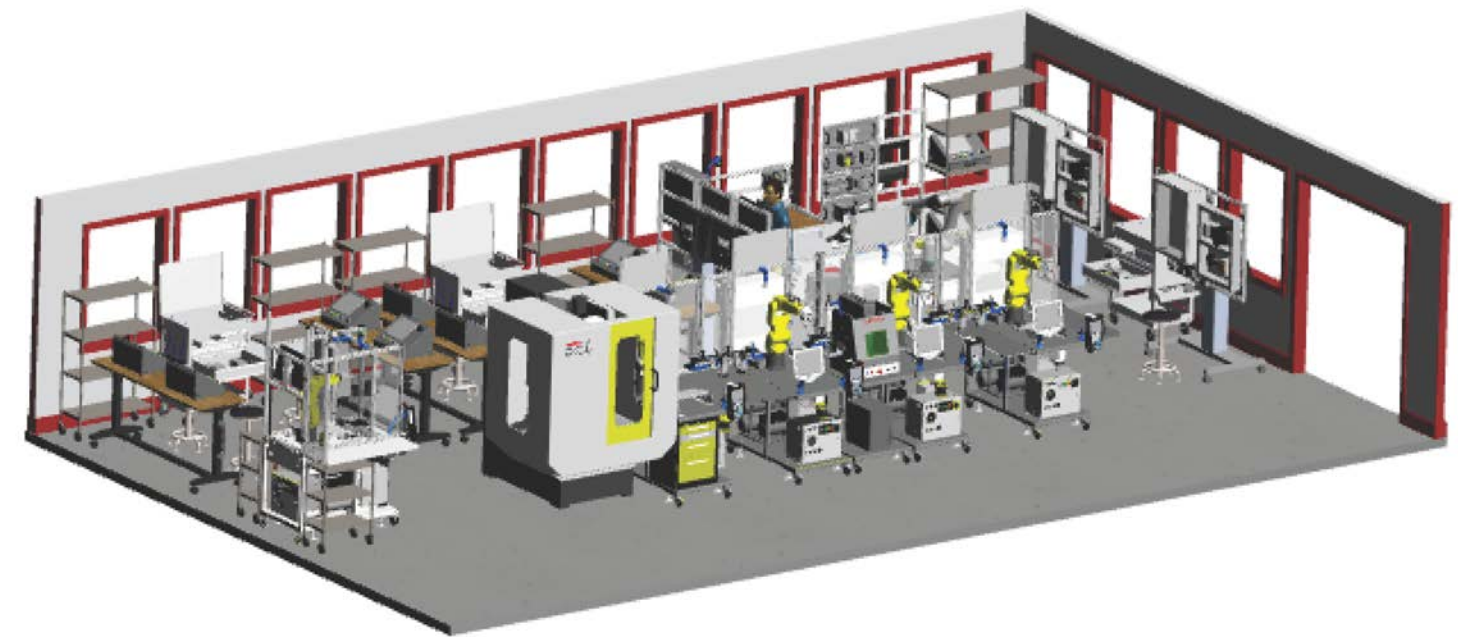
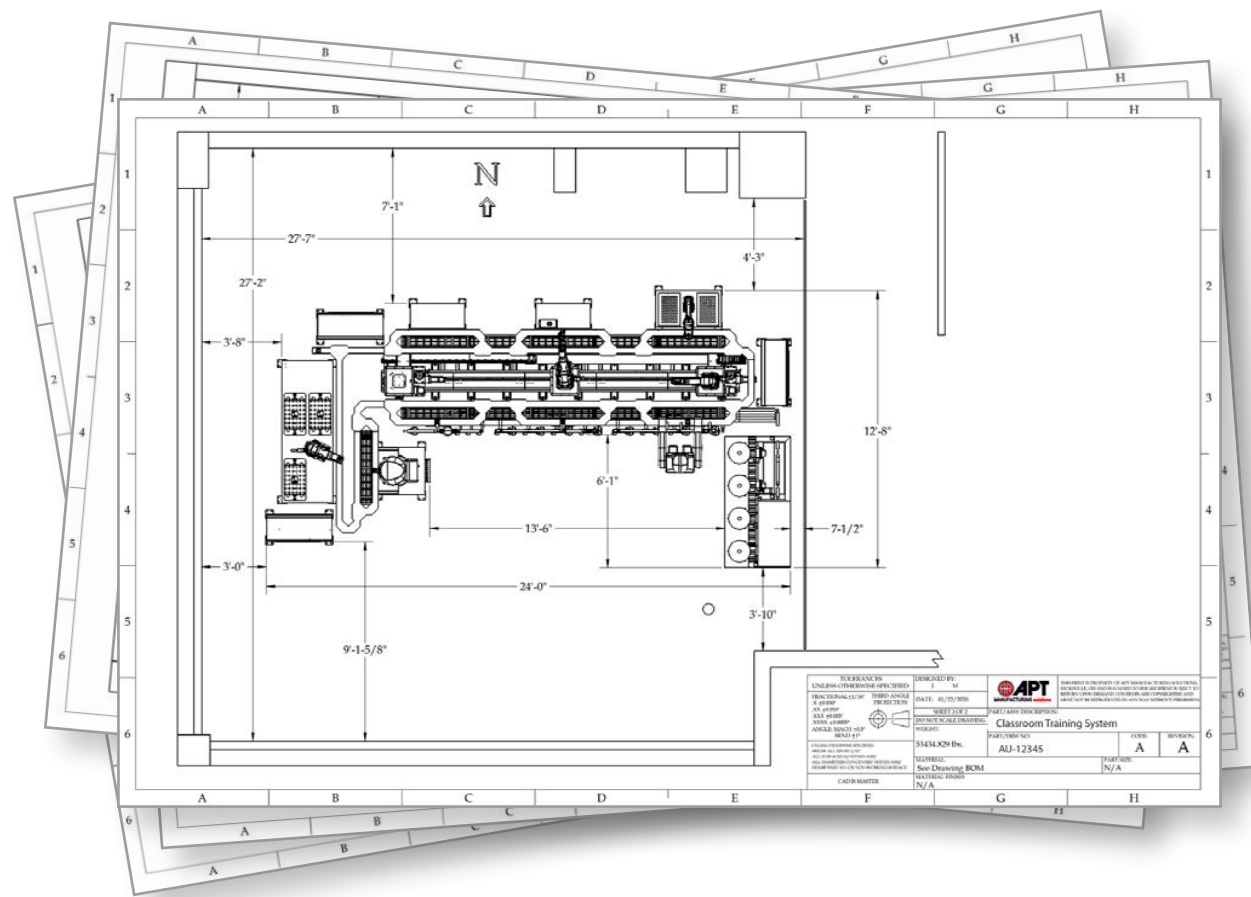

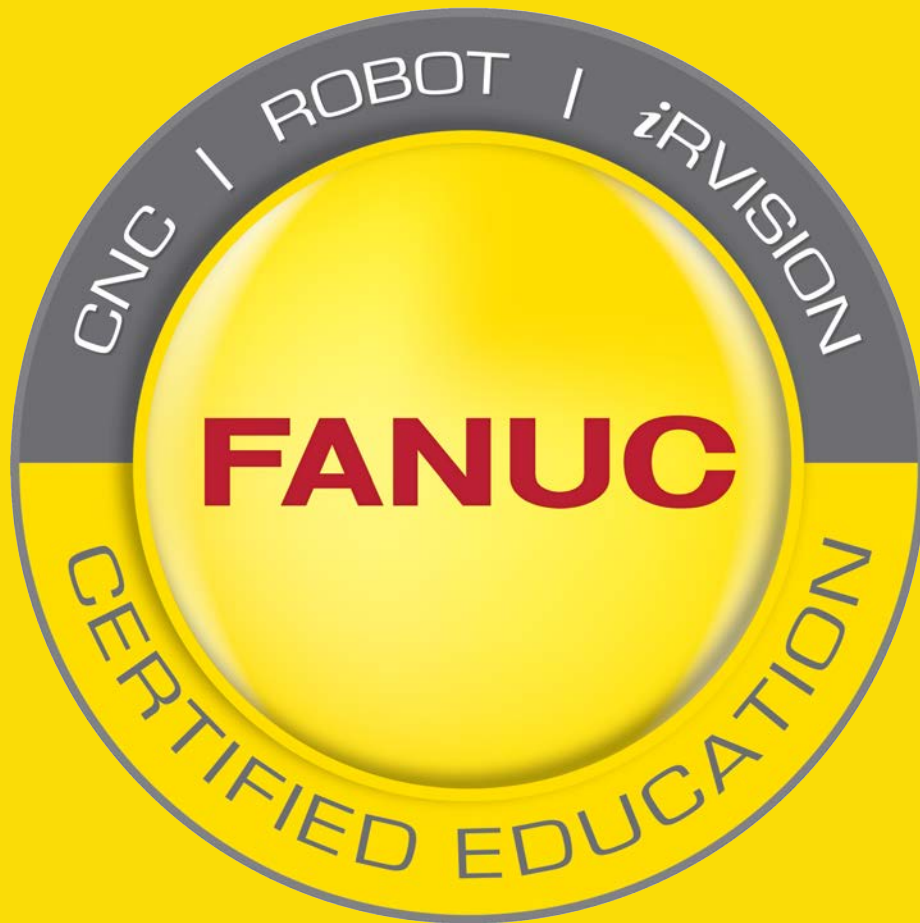

Contact your authorized FANUC education solutions provider
for more information

Published February 2022

fanucamerica.com/education
aptmfg.com/education