



Atlanta Attachment Company

Automotive Division



Innovative Technology for the Sewn Products Industry Worldwide

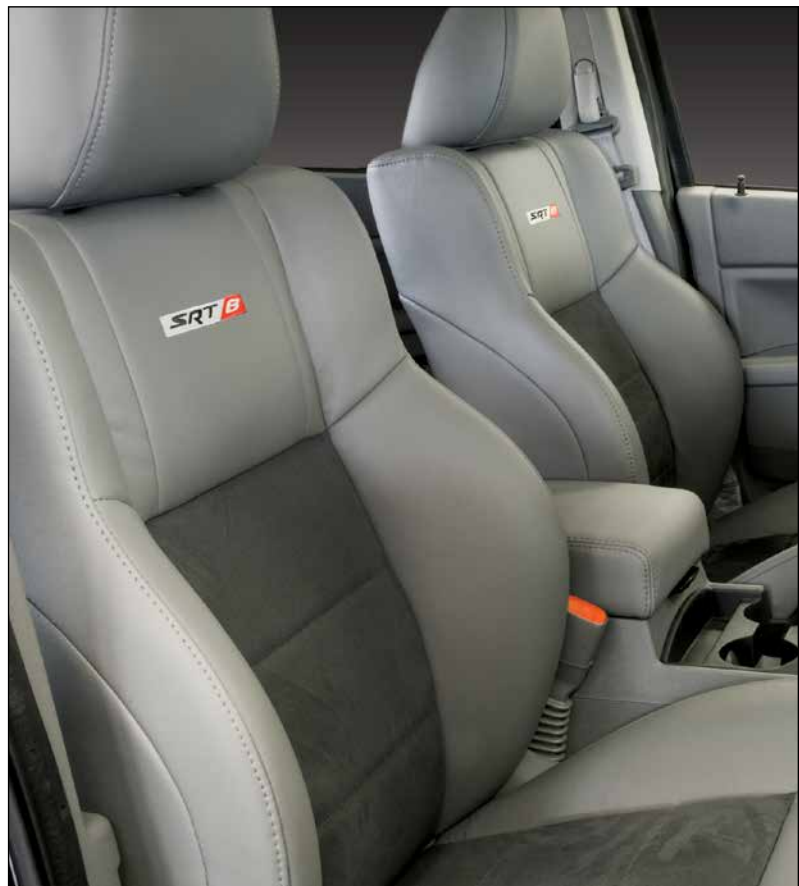

Atlanta Attachment Company Automotive Division



Innovative Technology for the Sewn Products Industry Worldwide

© 2012 Atlanta Attachment Company. All rights reserved.

All materials contained herein are additionally protected by United States copyright law and may not be used, disclosed, reproduced, distributed, published or sold without the express written consent of Atlanta Attachment, which consent may be withheld in Atlanta Attachment's sole discretion. You may not alter or remove any copyright, trademark or other notice from copies of these materials.

Atlanta Attachment Company, AAC, Atlanta Parts Depot, "Sudden Service", Sewing Automation, individually and when used in combination are registered trademarks of Atlanta Attachment Company.

11402042212

Corporate Headquarters

Atlanta Attachment Company is a global supplier of sewing workstations, automated sewing equipment, folders, attachments and other labor saving devices for the apparel industry. Our equipment is built from the highest quality materials and with dedicated workmanship. The Atlanta Attachment brand is well known throughout the sewn products industry for its innovative technology.

Our line of apparel production equipment is developed for working with materials such as knit, woven and synthetic. A few of the many products sewn include placket shirts, circular collar and flat collar tee-shirts. AAC offers many sewing workstations for sweatshirts, sweatpants, and hooded sweatshirts. Equipment is also available for producing mens and ladies underwear, blouses and pajamas. More equipment is available for sewing drapery, caps and aprons. Multi-head embroidery equipment can be used for items needing personalization.

AAC stocks a wide variety of sewing machine attachments and folders but from it's inception has specialize in custom sewing machine folders. The Atlanta Parts Depot division delivers one-stop shopping for replacement sewing machine parts.

Our manufacturing facility in Lawrenceville Ga, USA is capable of handling any type of fabrication needed for our equipment.

- Engineering & Design
- Mechanical Assembly
- Electronic Assembly
- Electrical Assembly
- Sub-assembly
- CNC Milling up to 120"
- CNC Lathe
- Manual Milling
- Manual Lathe
- Surface Grinding
- Metal Fabrication
- Metal Finishing
- Tube Bending
- Cutting: Laser, Plasma, Water Jet
- Heat Treating
- Welding
- Painting
- Warehousing
- Distribution & Installation





QR Code for quick accesses to our location in google maps.

Atlanta Attachment Company is a recognized sewn products industry leader in automated workstations, labor saving devices, folders and ergonomic risk reduction. The company, founded in 1969, has made its policy of **Sudden Service**[®] a way of life in all aspects of operation.

Location

362 Industrial Park Drive
Lawrenceville, GA 30046 USA
+1 (770) 963-7369
FAX +1 (770) 963-7641

Sales & Technical Support

Sales



Hank Little
President



Randy Clark
VP Midwest Sales



Eugenio Fonts
VP International Sales



Darrell Miller
Regional Sales Manager



Eric Iverson
Regional Sales Manager



John Price
VP Folder Division



Sandra Morrison
Director of Corporate Admin.



Jose Pulido
Latin America Sales

Inside Sales



David Wall
Inside Sales



Scott Ake
Inside Sales



Michael Leathers
Inside Sales



Celso Alvarez
Inside Sales





The "A" Team



William Richey
VP Customer Service



Jurgen Van Osch
Service Manager



Faye Williams
Customer Service
Executive Assistant



Jeff Moore
Service Technician



Jim Loewen
Service Technician



Jose Ortiz
Service Technician

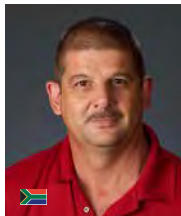

Brett Button
Service Technician



Frank Campos
Service Technician



Justin Ozbolt
Service Technician



Hector Leon
Service Technician

Technical Support

Languages Represented:
Other than English

-  Portuguese
-  German
-  Dutch
-  Afrikaans
-  Spanish



Roberto Fernandez
Service Technician

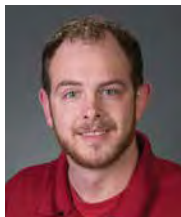

Adam Broich
Service Technician



Craig Reichart
Service Technician



Michael Sewing
Service Technician



Rene Montano
Service Technician



Symbol Index

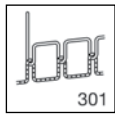

301
Lockstitch



Maximum sewing speed

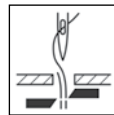

Underbed thread trimmer

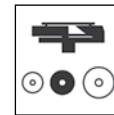

Vertical hook large

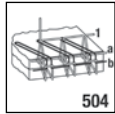

504
Three thread overlock

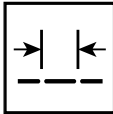

Maximum stitch length

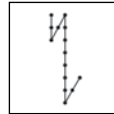

Seam backtacking,
automatic

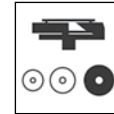

Vertical hook extra large

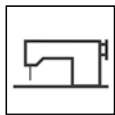

Flat bed

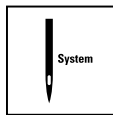

Needle system



Bottom feed, needle feed
and alternating feed

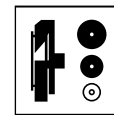

Horizontal hook
large and extra large

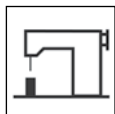

Post bed

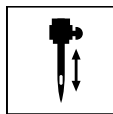

Needle bar stroke

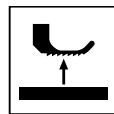

Footlift height

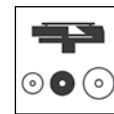

Vertical hook large



Cylinder arm

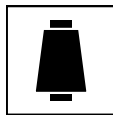

Thread size

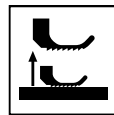

Stepping height

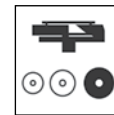

Vertical hook extra large

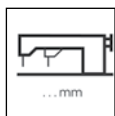

Extended head



Sewing field dimensions



Automatic presser footlift

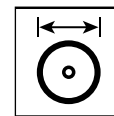

Wheel diameter

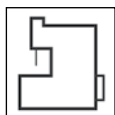

Box type

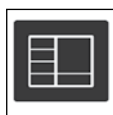

Serial bus



Wattage



Titanium wheel



Knife

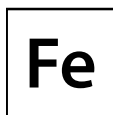

Steel wheel

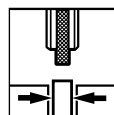

Bottom wheel width



Equipment Index

Manufacturers

Vetron

5000/5010/5020/5030	10
5100/5110/5120/5130	11
5064/5164.....	13

Atlanta Attachment Company

CM0900 Series	14
PLC 1760-7-C.....	15
1356	16
1357F	17
1357M.....	18
1357F20	19
1380 PY6	20
5504-J-34.....	21
1410X86001	45

Juki

AMS-22E-2516 & AMS-22E-3020	22
AMS 210EHL Series.....	23
LS 1342-7.....	24
LU 1510N-7 & LU 1560N-7	25
PLC 1710-7 & PLC 1760-7.....	26
MO 6916 G.....	27
G81200CZ122	28

KMF

441	29
3110/1.....	30
3121	31
3145/1 & 3145/4.....	32
3150/1.....	33

Mitsubishi

PLGE Series	34
-------------------	----

Pfaff

1245	35
2235	36
2521	37
2545/2546.....	38
2595/2596.....	39
3108	40
3721	41
3745	42

Singer

300U-194A	43
-----------------	----

SunStar

SPS/C-8050H.....	44
------------------	----

ACCESSORIES

Tables, Stands	48
Motors, Pedals	48
Attachments and Folders.....	49
Satellite Plus.....	50
Automated Parts Management System	51
Serial Bus Control System.....	52
Replacement Parts.....	54

Custom Designed Equipment.....	46
--------------------------------	----

Machine Type

Flatbed Lockstitch

5000/5010/5020/5030	10
5100/5110/5120/5130	11
LU 1510N-7 & LU 1560N-7	25
1245	35
2235	36
2545/2546.....	38

Flatbed Chainstitch

300U-194A	43
-----------------	----

Cylinderbed Lockstitch

LS 1342-7.....	24
----------------	----

Postbed Lockstitch

PLC 1760-7-C.....	15
PLC 1710-7 & PLC 1760-7.....	26
2595/2596.....	39

Overedge

5504-J-34	21
MO 6916 G.....	27
G81200CZ122	28

Programmable Pattern Tackers

AMS-22E-2516 & AMS-22E-3020	22
AMS 210EHL Series.....	23
PLGE Series	34
SPS/C-8050H.....	44
3721	41
3108	40

Special Purpose

5064/5164.....	13
1356	16
1357M.....	18
1380 PY6	20
3110/1.....	30
3150/1.....	33
3121	31
3145/1 & 3145/4.....	32
3745	42
2521	37

Operation

Air Bags	
3745	42
Consoles	
5000/5010/5020/5030	10
5100/5110/5120/5130	11
CM0900 Series	14
PLC 1760-7-C	15
PLC 1710-7 & PLC 1760-7	26
300U-194A	43
Floor Mats	
G81200CZ122	28
1245	35
2595/2596	39
300U-194A	43
Rest, Head and Arm	
LS 1342-7	24
LU 1510N-7 & LU 1560N-7	25
PLC 1710-7 & PLC 1760-7	26
2235	36
Seats, Bench, 60/40, Bucket	
5000/5010/5020/5030	10
5100/5110/5120/5130	11
CM0900 Series	14
1356	16
1357F	17
1357M	18
1357F20	19
1380 PY6	20
5504-J-34	21
LU 1510N-7 & LU 1560N-7	25
MO 6916 G	27
441	29
3110/1	30
3121	31
3145/1 & 3145/4	32
3150/1	33
2235	36
2521	37
2545/2546	38
3745	42
300U-194A	43
Seats, Documentation Seams	
2521	37
3745	42
Miscellaneous Operations:	
Tack Sew	
AMS-22E-2516 & AMS-22E-3020	22
PLGE Series	34
3721	41
3108	40
SPS/C-8050H	44

Operation

Decorative Sew	
5000/5010/5020/5030	10
5100/5110/5120/5130	11
PLC 1760-7-C	15
AMS-22E-2516 & AMS-22E-3020	22
AMS 210EHL Series	23
LU 1510N-7 & LU 1560N-7	25
PLC 1710-7 & PLC 1760-7	26
PLGE Series	34
2235	36
2545/2546	38
2595/2596	39
3108	40
3721	41
SPS/C-8050H	44
1410X86001	45
J-Clip Module	
1380 PY6	20
Duon/Isofix Application	
1357F	17
1357M	18
Wire Pocket	
3145/1 & 3145/4	32
Embroidery	
CM0900 Series	14
Special Purpose	
5064/5164	13
Electronic Motors	
Efka DC 1550/AB320	48
Efka DC 1500/AB320	48
Juki SC510DS	48
Tables and Stands	48
Foot Pedals	48
Attachments and Folders	49
Satellite Plus	50
Automated Parts Management System	51
Serial Bus Control System	52
Replacement Parts	54
Special Purpose Custom Machinery	46

Introducing VETRON

Awarded **TEXPROCESS Innovation Award 2011**, this innovative machine design leaves the conventional way to build a sewing machine behind. Instead of a housing as a main unit that carries all mechanical parts, this so-called "frame" now simply plays a supporting role and can be easily exchanged between alternative models. All functional components are merged in "technology modules", which are fully interchangeable. The factory pre-settings guarantee an exchange of modules without further adjustments. With this innovation you are able to adapt the machine to any future configuration... in a few minutes it is possible to convert a flatbed into a long arm machine.

Through the consistent use of state of the art electronic control it became possible to make all machine settings programmable into memory and thus recallable. This allows the process parameters to be free from operators influence and identical every time the program is recalled. The innovative dynamic machine parameter, based on the actual speed and the permanent measurement of the material thickness, opens new possibilities of production quality, process security and the reduction of cycle times.

FEATURES:

- All control elements including the bobbin winder, electronic hand wheel and reverse button are placed at the head module in the user's direct field of view.
- Tilt-assistant for easy cleaning and maintenance
- Optimized hook lubrication with fresh oil
- Noise-reduced machine features
- No use of compressed air
- All settings are programmable and storable
- User identification with USB dongle
- Permanent measurement of material thickness thereby dynamic adjustment of needle thread tension, top feed stroke, sewing speed and sewing foot pressure
- Automatic top feed stroke adjustment at cross seams
- Stitch-n-Stitch bar tacking

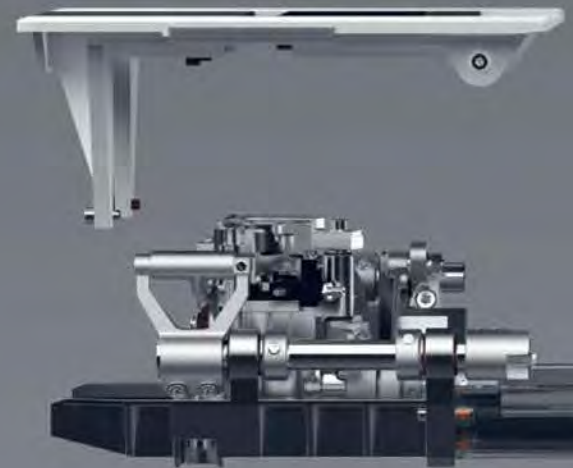

FLATBED MACHINE



PATTERN SEWING



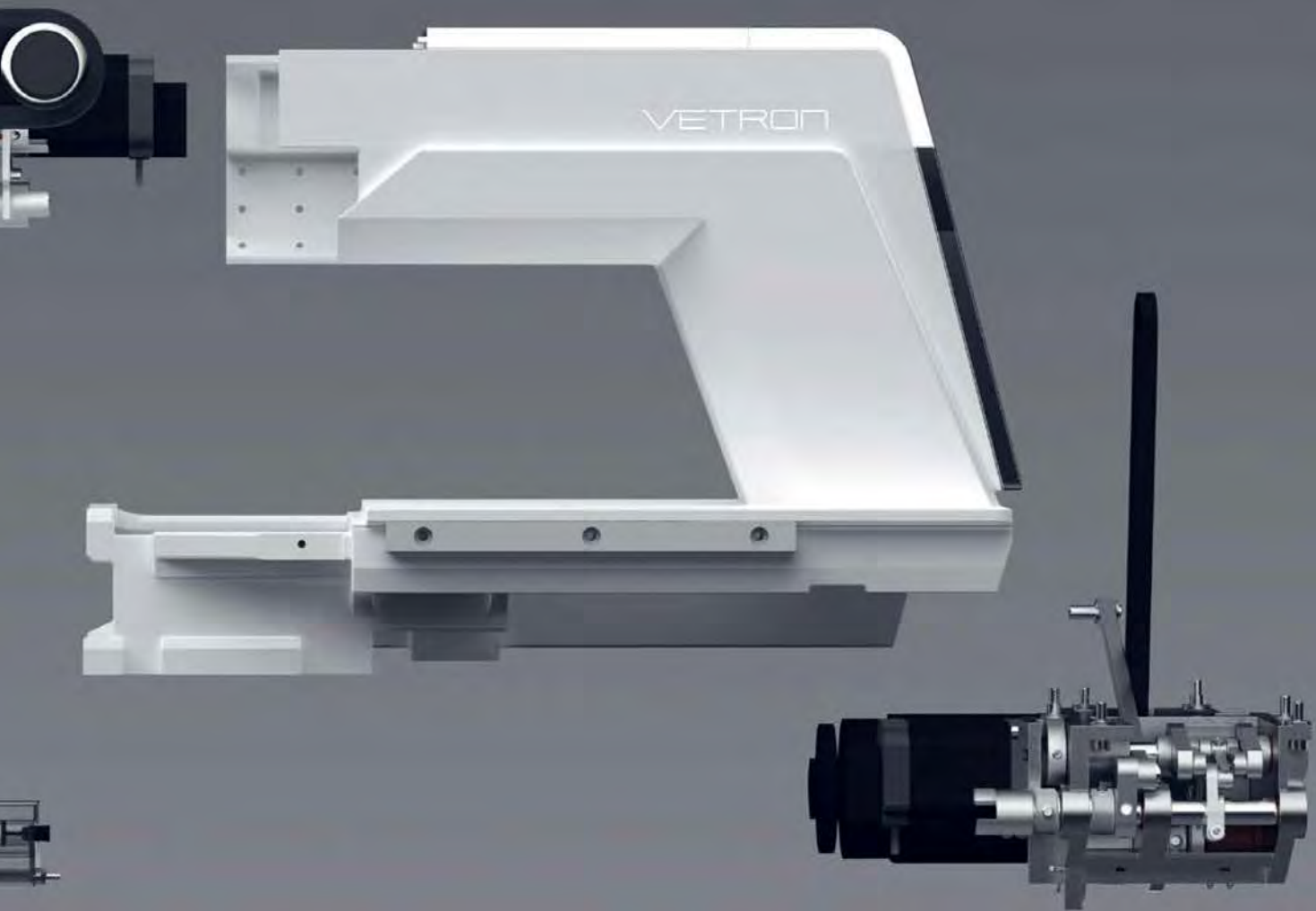

MACHINE



LONGARM MACHINE

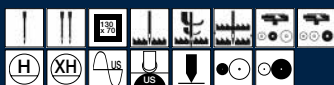

POSTBED MACHINE



ULTRASONIC WELDING MACHINE



VETRON | 5000/5010/5020/5030



Flatbed Sewing Machines

- All control elements including bobbin winder, electronic hand wheel and reverse button are placed at the head module in the user's direct field of view
- Integrated, electric bobbin winder (continuous winding process even when machine stops)
- Integrated and dimmable sewing light
- Extremely solid construction of housing
- Tilt-assistant for easy cleaning and maintenance
- Optimized hook lubrication with fresh oil
- Integrated motor
- Noise-reduced machine features
- No use of compressed air
- Stored production settings allow for fast and precise set-up of the machine
- User identification by USB-dongle
- Permanent measurement of material thickness thereby dynamic adjustment of needle thread tension, top feed stroke, sewing speed and sewing feet pressure
- Automatic top feed stroke adjustment at cross seams
- Stitch-in-stitch bar tacking

» 50-	00	1x301	4000*	•	12	134-135** 90-180	40	XL	20	9	10/3**	350x130	
	10	1x301	4000*	•	12	134-135** 90-180	40	XXL	20	9	10/3**		
» DOUBLE NEEDLE:													
» 50-	20	2x301	4000*	•	12	134-135** 90-180	40	XL	20	9	10/3**	350x130	
	30	2x301	4000*	•	12	134-135** 90-180	40	XXL	20	9	10/3**		
			rpm		mm		mm		mm			mm	

* Depending on process / Abhängig von der Anwendung
 ** Depending on version / Abhängig von der Version

www.atlatt.com • sales@atlatt.com

PATENTS: Our equipment may be covered by one or more patents.
 Please go to the following web page for an up-to-date patent list: www.atlatt.com/patents.php
 © 2017 Atlanta Attachment Co.

362 Industrial Park Drive
 Lawrenceville, GA 30046 USA
 +1 (770) 963-7369 • FAX +1 (770) 963-7641



Atlanta Attachment Company
 The Company that
Sudden Service®
 built



Longarm Sewing Machines

- All control elements including bobbin winder, electronic hand wheel and reverse button are placed at the head module in the user's direct field of view
- Integrated, electric bobbin winder (continuous winding process even when machine stops)
- Integrated and dimmable sewing light
- Extremely solid construction of housing
- Tilt-assistant for easy cleaning and maintenance
- Optimized hook lubrication with fresh oil
- Integrated motor
- Noise-reduced machine features
- No use of compressed air
- Stored production settings allow for fast and precise set-up of the machine
- User identification by USB-dongle
- Permanent measurement of material thickness thereby dynamic adjustment of needle thread tension, top feed stroke, sewing speed and sewing feet pressure
- Automatic top feed stroke adjustment at cross seams
- Stitch-in-stitch bar tacking

» 51-	00	1x301	4000*	•	12	134-135** 90-180	40	XL	20	9	10/3**	680x130
	10	1x301	4000*	•	12	134-135** 90-180	40	XXL	20	9	10/3**	
» DOUBLE NEEDLE:												
» 51-	20	2x301	4000*	•	12	134-135** 90-180	40	XL	20	9	10/3**	680x130
	30	2x301	4000*	•	12	134-135** 90-180	40	XXL	20	9	10/3**	
			rpm		mm		mm		mm			mm

* Depending on process / Abhängig von der Anwendung

** Depending on version / Abhängig von der Version

www.atlatt.com • sales@atlatt.com

PATENTS: Our equipment may be covered by one or more patents.
Please go to the following web page for an up-to-date patent list: www.atlatt.com/patents.php
© 2017 Atlanta Attachment Co.

362 Industrial Park Drive
Lawrenceville, GA 30046 USA

+1 (770) 963-7369 • FAX +1 (770) 963-7641



Atlanta Attachment Company

The Company that
Sudden Service®
built

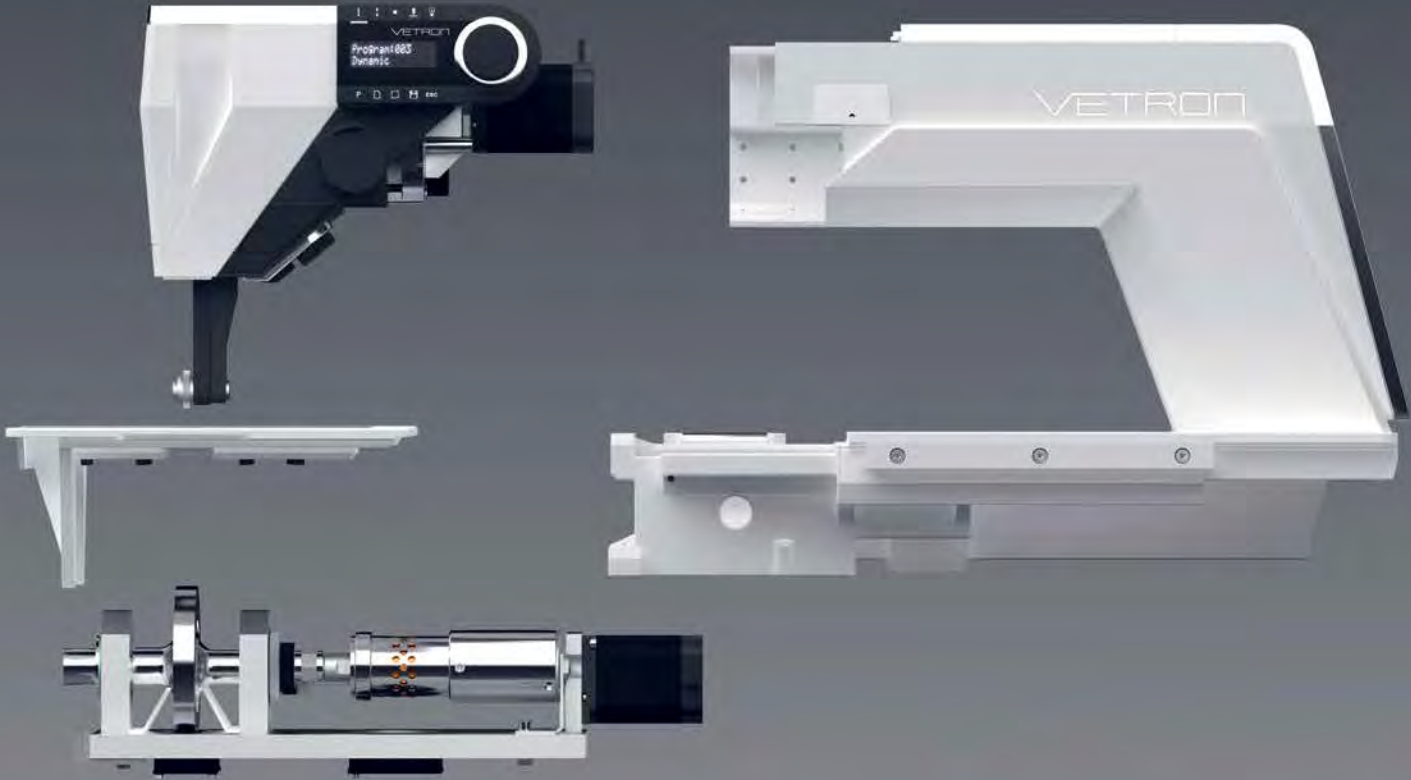

Ultrasonic Welding Machines

- High-precision titanium or hardened steel sonotrode – Made in Germany
- Additional welding modes like baste welding, spot welding or “cut & seal” selectable
- Anvil wheel from 25 to 45 mm diameter
- Anvil wheel with adaptable puller function
- Welding of tight radiuses due to an anvil diameter of 25 mm
- Modular design (joint design for welding and sewing machines, for increased flexibility)
- No use of compressed air
- Welding with continuous or dynamic speed
- Digital welding generator with 500 or 1000 Watt (optional)
- Stepping motors for: Anvil wheel, sonotrode (separately controlled), welding gap and welding pressure
- All machine parameters are programmable and storable
- Simplified & intuitive program concept
- Setup assistant
- User identification with USB dongle possible
- Free selectable access permission
- Snap-in control panel
- Network port for central administration of the machines (optional)

www.atlatt.com • sales@atlatt.com

PATENTS: Our equipment may be covered by one or more patents.
Please go to the following web page for an up-to-date patent list: www.atlatt.com/patents.php
© 2017 Atlanta Attachment Co.

362 Industrial Park Drive
Lawrenceville, GA 30046 USA
+1 (770) 963-7369 • FAX +1 (770) 963-7641



Atlanta Attachment Company
The Company that
Sudden Service®
built

5064/5164 | VETRON

Anvil wheel of 25 and 45 mm diameter (scale 1:1)

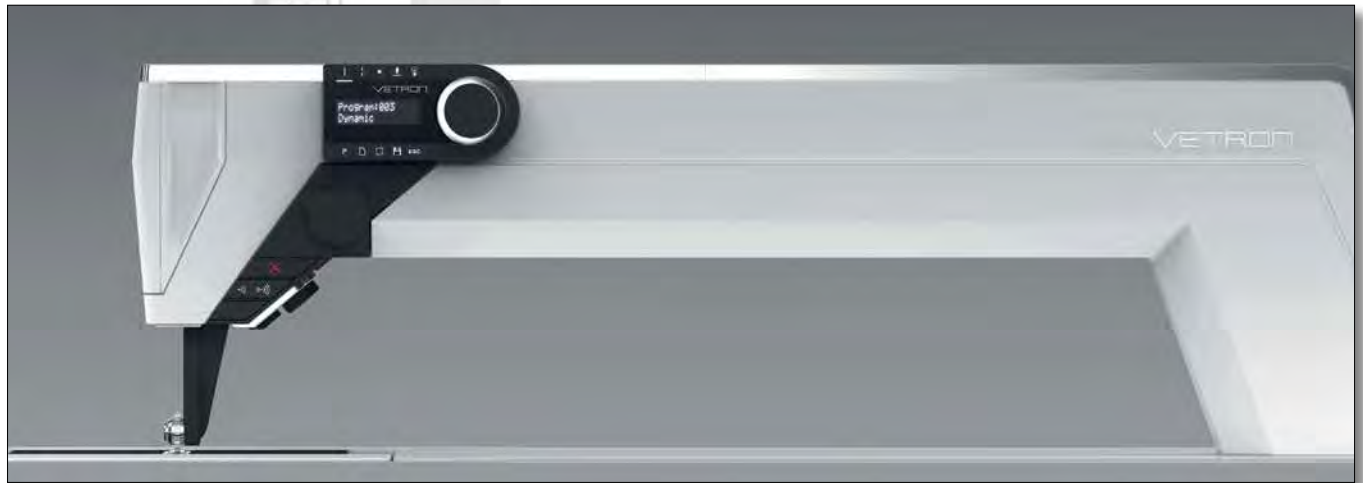

		WATT	(MAX)		Ti		Fe		(MAX)	
5064-	1000	500	30	25-45	•			10	9.5	350x130
	2000	1000	30	25-45	•			10	9.5	
	2300	1000	30	25-45		•	•	13	12.5	
5164-	1000	500	30	25-45	•			10	9.5	680x130
	2000	1000	30	25-45	•			10	9.5	
	2300	1000	30	25-45		•	•	13	12.5	
			rpm	mm				mm	mm	mm

www.atlatt.com • sales@atlatt.com

PATENTS: Our equipment may be covered by one or more patents. Please go to the following web page for an up-to-date patent list: www.atlatt.com/patents.php
© 2017 Atlanta Attachment Co.

362 Industrial Park Drive
Lawrenceville, GA 30046 USA
+1 (770) 963-7369 • FAX +1 (770) 963-7641



Atlanta Attachment Company
The Company that
Sudden Service®
built

Atlanta Attachment | E0900 Series



Automated Embroidery System

- Product may be personalized for each customer
- Raises price point, increasing profits as no outsourcing required
- Small quantities produced on demand
- Customer loyalty enhanced
- Multi-head design, high production, low cost
- Scan any logo and digitize in house
- AAC offers complete training and logo digitizing service

Technical Specifications:

- 9 needles, 9 colors
- Built in noise reduction technology
- Embroidery Field: 400mm x 450mm
- All steel bridge style construction
- LCD color monitor
- Solid steel rotary hook system
- Complete hoop assortment included
- Built-in disk drive and USB port
- Direct connect to computer upon request
- Built-in rotary type thread break sensors
- Automatic thread trimmers
- Automatic color changes
- Memory retention after shut down
- Removable support table top for flat goods

www.atlatt.com • sales@atlatt.com

PATENTS: Our equipment may be covered by one or more patents.
Please go to the following web page for an up-to-date patent list: www.atlatt.com/patents.php
© 2017 Atlanta Attachment Co.

362 Industrial Park Drive
Lawrenceville, GA 30046 USA
+1 (770) 963-7369 • FAX +1 (770) 963-7641



Atlanta Attachment Company

The Company that
Sudden Service®
built

Postbed, Walking Foot, Lockstitch with Large Hook, Automatic Underbed Thread Trimmer, Automatic Footlift, Automatic Backtack, and Automatic Lubrication

- 2 needle modified for foam fill in place head rests, the needles are moved in line to create 2 tight stitch lines in close proximity to each other in order to eliminate the necessity of taping seams after sewing.
- Walking Foot – Bottom rectangular feed movement, Top feed with alternating presser feet, and needle feed.
- Dual thread tension
- Dial adjustment of walking foot vertical movement
- Bottom feed micro-adjustment
- Dial adjustment of stitch length
- Built in bobbin winder
- DL Device for instantaneous adjustment of walking foot vertical movement to enable crossing of heavy seams
- Hook safety clutch

Optional:

- Edge guides
- Material guides
- Folders
- Binder attachments



PLC 1760-7-C	1x301	2500	9	134x35 to size 160	36	L	16	9	10/3**	255
		rpm	mm		mm		mm			mm

www.atlatt.com • sales@atlatt.com

PATENTS: Our equipment may be covered by one or more patents. Please go to the following web page for an up-to-date patent list: www.atlatt.com/patents.php
© 2017 Atlanta Attachment Co.

362 Industrial Park Drive
Lawrenceville, GA 30046 USA
+1 (770) 963-7369 • FAX +1 (770) 963-7641



Atlanta Attachment Company
The Company that
Sudden Service®
built



Semi-Automatic Sewing Unit for Assembling Elastic Seat Support Straps. Serial Bus Controller, 2 Lockstitch Sewing Heads

- Approximately 7 straps per minute
- 2 Flatbed needle feed lockstitch sewing heads with backtack, footlift, and underbed thread trimmer
- Elastic web feeder and cutter
- Turn-up folders to facilitate loading metal clips
- Turn-down folders fold material after hooks are loaded.
- Hand-wheel size adjustment
- Operator just loads hooks and wipes switch. (de-skills operation)
- DL Device for instantaneous adjustment of walking foot vertical movement to enable crossing of heavy seams
- Hook safety clutch

1356	•	5000	0-44	DBX1-14	31.8		11
		rpm	mm		mm		mm

www.atlatt.com • sales@atlatt.com

PATENTS: Our equipment may be covered by one or more patents. Please go to the following web page for an up-to-date patent list: www.atlatt.com/patents.php
© 2017 Atlanta Attachment Co.

362 Industrial Park Drive
Lawrenceville, GA 30046 USA
+1 (770) 963-7369 • FAX +1 (770) 963-7641



Atlanta Attachment Company
The Company that
Sudden Service®
built

1357F | Atlanta Attachment

Semi-Automatic workstation for sewing IsoFix patches into seat backs, 2 moveable programmable pattern tacker sewing units, patented Serial Bus controller

- Two programmable pattern-tacker sewing units
- Sewing units arranged as mirror images
- Both heads move independently according to profile of seat back.
- Operator swipe switches for safe operation
- Dual head allows for simultaneous sewing of patches
- Tooling creates nest for patch, then clamps in place



1357F	1x301	2500	0.1-12.7	135x17 to size 140/22	10/3	•
		rpm	mm			

www.atlatt.com • sales@atlatt.com

PATENTS: Our equipment may be covered by one or more patents.
Please go to the following web page for an up-to-date patent list: www.atlatt.com/patents.php
© 2017 Atlanta Attachment Co.

362 Industrial Park Drive
Lawrenceville, GA 30046 USA
+1 (770) 963-7369 • FAX +1 (770) 963-7641



Atlanta Attachment Company
The Company that
Sudden Service®
built



Semi-Automatic, IsoFix button insertion unit, Patented Serial Bus controller, Button orientation, Color recognition

- Color scanners to verify seat and button color match
- Camera recognition and orientation to verify position of IsoFix button
- Automatic button feeder
- Automatic retainer washer feeder
- Laser light positioning aid
- Button and washer insertion

www.atlatt.com • sales@atlatt.com

PATENTS: Our equipment may be covered by one or more patents. Please go to the following web page for an up-to-date patent list: www.atlatt.com/patents.php
© 2017 Atlanta Attachment Co.

362 Industrial Park Drive
Lawrenceville, GA 30046 USA
+1 (770) 963-7369 • FAX +1 (770) 963-7641



Atlanta Attachment Company

The Company that
Sudden Service®
built

Semi-Automatic Kick Plate Sewing Workstation

- U-shaped design allows for ergonomic loading/unloading of cassette
- Entire kick plate sewn at one time
- Consistent margins
- Elastic, j-clips or duon held in place and sewn all in one operation
- Part is loaded while previous part is being sewn



1357F20	1x301	2500	0.1-12.7	135x17 to size 140/22	9	10/3
		rpm	mm			

www.atlatt.com • sales@atlatt.com

PATENTS: Our equipment may be covered by one or more patents. Please go to the following web page for an up-to-date patent list: www.atlatt.com/patents.php
© 2017 Atlanta Attachment Co.

362 Industrial Park Drive
Lawrenceville, GA 30046 USA
+1 (770) 963-7369 • FAX +1 (770) 963-7641



Atlanta Attachment Company
The Company that
Sudden Service[®]
built

Atlanta Attachment | 1380PY6



Specially Designed Work Aid, Programmable Sequence, Direct LCD Touch Screen Programmable, Stand Alone Patented Serial Bus Controller

- Stand alone, attachable to any sewing unit with electronic motor
- Expandable number of work bins (6 standard)
- Optical bin sequence
- No start switch if part not pulled from correct bin protected by light barrier
- Matches j-clip/duon to proper seam segment

Benefits:

- Ensured quality of end product
- Reduced costs due to missing j-clips
- Maintains proper sequence of parts

www.atlatt.com • sales@atlatt.com

PATENTS: Our equipment may be covered by one or more patents.
Please go to the following web page for an up-to-date patent list: www.atlatt.com/patents.php
© 2017 Atlanta Attachment Co.

362 Industrial Park Drive
Lawrenceville, GA 30046 USA
+1 (770) 963-7369 • FAX +1 (770) 963-7641



Atlanta Attachment Company

The Company that
Sudden Service®
built

5504-J-34 | Atlanta Attachment





Specialty Modified, 1-Needle 3-Thread Overedge (504 stitch), Variable Top-feed, Bottom Differential Feed

- Modified top feed mechanism to increase walking movement of top feed
- Upper and Lower needle bar bushings
- Automatic Lubrication
- Cartridge type oil filter and cooling fan
- Push button stitch length adjustment
- Variable top feed adjusted by lever with micro adjustment
- Bottom differential feed adjusted by lever with micro adjustment
- Thread & needle lubrication system
- High lift stepping foot (foot lifts during feed stroke)

Optional:

- Pneumatic foot lifter
- Vacuum chain cutter
- Gathering attachments



					
5504-J-34	1x504	6000	2.5-5	28.8	8
		rpm	mm	mm	mm

www.atlatt.com • sales@atlatt.com

PATENTS: Our equipment may be covered by one or more patents. Please go to the following web page for an up-to-date patent list: www.atlatt.com/patents.php
© 2017 Atlanta Attachment Co.

362 Industrial Park Drive
Lawrenceville, GA 30046 USA
+1 (770) 963-7369 • FAX +1 (770) 963-7641



Atlanta Attachment Company
The Company that
Sudden Service®
built

Juki | AMS22E-2516/-3020



Computer-Controlled Cycle Machines with Input Function, Direct-Drive Servo-Motor, High Speed, Reduced Cycle Time, Operation Panel Direct Programming







- AC Servo-motor Direct-drive
- Built-in bed feed mechanism
- Underarm free space maximized
- Needle bar reverse mechanism for increased and maximum clearance during clamp load and unload process
- IP410 touch screen operator panel (color)
- 200 program capacity (20,000 stitches per pattern)
- Compact Flash storage media
- Oil-less sewing head (hook lubricated)
- Two stage pneumatic clamp

Sewing fields:

- AMS-22E-2516 25cm x 16cm
- AMS-22E-3020 30cm x 20cm

Optional:

- Programming software PM1
- Needle thread clamp device
- Needle cooler
- Milling unit
- Thread tension controller
- Pneumatic inverted clamping device
- One touch utility clamp for quick change of patterns

								
AMS	2516	1x301	2500	.01-12.7	135x17 to size 110/18	41.2	XL	20
22E	3020	1x301	2500	.01-12.7	135x17 to size 110/18	41.2	XL	20
			rpm	mm		mm		mm

www.atlatt.com • sales@atlatt.com

PATENTS: Our equipment may be covered by one or more patents. Please go to the following web page for an up-to-date patent list: www.atlatt.com/patents.php
© 2017 Atlanta Attachment Co.

362 Industrial Park Drive
Lawrenceville, GA 30046 USA
+1 (770) 963-7369 • FAX +1 (770) 963-7641



Atlanta Attachment Company
The Company that
Sudden Service®
built

Computer-Controlled Cycle Machines with Input Function, Stepping-Motor Drive, High Speed, Reduced Cycle Time, Touch Panel Direct Programming

- AC Servo motor direct drive
- Rapid acceleration and deceleration
- Stepping motor drive (X-Y axis)
- Stepping motor controlled thread trimmer
- Active tension, needle thread control
- Programmable intermediate presser foot height
- IP-400 operation panel with programmable functions, and multiple languages
- Memory storage capacity of 200 patterns and a total of 20,000 stitches per pattern can be increased with external media (Compact Flash card) capable of storing 999 patterns and 50,000 stitches per pattern
- Color LCD display of data and functions
- Dry sewing head, Hook lubricated automatically
- Pneumatic work clamp, 2-Stage clamp standard for EHL
- Network capable via (RS-232C: Reverse type) cable connection

Optional:

- Programming software PM-1
- Pneumatic inverted clamp device
- Milling unit
- Needle cooler
- One touch utility clamp for quick change of patterns



Model Number	Sewing Field	
	X (mm)	Y (mm)
AMS-210EHL-1306	60	130
AMS-210EHL-1510	150	100
AMS-210EHL-2206	220	60
AMS-210EHL-2210	220	100

AMS 210EHL							
	1x301	2700	0.1-12.7	135x17 to size 21	41.2	XL	20
		rpm	mm		mm		mm

www.atlatt.com • sales@atlatt.com

PATENTS: Our equipment may be covered by one or more patents. Please go to the following web page for an up-to-date patent list: www.atlatt.com/patents.php
© 2017 Atlanta Attachment Co.

362 Industrial Park Drive
Lawrenceville, GA 30046 USA
+1 (770) 963-7369 • FAX +1 (770) 963-7641



Atlanta Attachment Company
The Company that
Sudden Service®
built

Juki | LS 1342-7



Cylinder-Bed, Walking Foot, Lockstitch with Large Hook, Automatic Underbed Thread Trimmer, Automatic Footlift, Automatic Backtack

- Unison Feed – Bottom feed, Top feed with alternating presser feet and Needle feed
- Dial adjustment of stitch length
- Dial adjustment of walking foot vertical height movement
- Dual thread tension
- Bottom feed micro-adjustment
- DL Device – Instantaneous adjustment of walking foot vertical movement to enable crossing of heavy seams
- Built-in bobbin winder
- Hook safety clutch

Optional:

- Edge guides
- Material guides
- Folders
- Binder attachments



LS 1342-7	1x301	2500	6	137x17 to size 180	36	L	16	9	255
		rpm	mm		mm		mm		mm

www.atlatt.com • sales@atlatt.com

PATENTS: Our equipment may be covered by one or more patents. Please go to the following web page for an up-to-date patent list: www.atlatt.com/patents.php
© 2017 Atlanta Attachment Co.

362 Industrial Park Drive
Lawrenceville, GA 30046 USA
+1 (770) 963-7369 • FAX +1 (770) 963-7641



Atlanta Attachment Company

The Company that
Sudden Service®
built







1-needle, Unison-feed, Lockstitch Machine with Vertical-axis Large Hook

- Unison feed – Bottom feed, Top feed with alternating presser feet, and Needle feed
- Dial adjustment of stitch length
- Dial adjustment of walking feet vertical height movement
- Dual thread tension
- Bottom feed micro-adjustment
- Built-in bobbin winder
- Hook safety clutch engaged with push button



Optional:

- DL Device – Instantaneous adjustment of walking foot vertical movement to enable crossing of heavy seams
- AE-10 – Bobbin thread run-out detector
- Edge guide
- Material guide
- Folders
- Binder attachments

							
1510N-7	1x301	3000	9	135 x 17 180	XL	16	255
» DOUBLE NEEDLE:							
1560N-7	2x301	2500	9	135 x 17 180	XL	16	255
		rpm	mm			mm	mm

www.atlatt.com • sales@atlatt.com

PATENTS: Our equipment may be covered by one or more patents. Please go to the following web page for an up-to-date patent list: www.atlatt.com/patents.php
© 2017 Atlanta Attachment Co.

362 Industrial Park Drive
Lawrenceville, GA 30046 USA
+1 (770) 963-7369 • FAX +1 (770) 963-7641



Atlanta Attachment Company
The Company that
Sudden Service®
built

Juki | PLC 1710-7/1760-7



Postbed, Walking Foot, Lockstitch with Large Hook, Automatic Underbed Thread Trimmer, Automatic Footlift and Backtack

- Walking Foot – Bottom rectangular feed movement,
- Top feed with alternating presser feet, and needle feed.
- Dual thread tension
- Dial adjustment of walking foot vertical movement
- Bottom feed micro-adjustment
- Dial adjustment of stitch length
- Built-in bobbin winder
- DL Device for instantaneous adjustment of walking foot vertical movement to enable crossing of heavy seams
- Hook safety clutch

Optional:

- Edge guides
- Material guides
- Folders
- Binder attachments



PLC 1710-7	1x301	2500	9	134x35 to size 160	36	L	16	255
» DOUBLE NEEDLE:								
PLC 1760-7	1x301	2500	9	134x35 to size 160	36	L	16	255
		rpm	mm		mm		mm	mm

www.atlatt.com • sales@atlatt.com

PATENTS: Our equipment may be covered by one or more patents. Please go to the following web page for an up-to-date patent list: www.atlatt.com/patents.php
© 2017 Atlanta Attachment Co.

362 Industrial Park Drive
Lawrenceville, GA 30046 USA
+1 (770) 963-7369 • FAX +1 (770) 963-7641



Atlanta Attachment Company
The Company that
Sudden Service®
built

Adjustable Gathering Workstation

- Gathers work piece for added fullness when going around interior contours
- Gathering turns on/off with the press of a knee switch
- All feed wear components run in constant oil bath for greater machine/component longevity
- Amount of gather is easily adjusted without tools



www.atlatt.com • sales@atlatt.com

PATENTS: Our equipment may be covered by one or more patents.
Please go to the following web page for an up-to-date patent list: www.atlatt.com/patents.php
© 2017 Atlanta Attachment Co.

362 Industrial Park Drive
Lawrenceville, GA 30046 USA
+1 (770) 963-7369 • FAX +1 (770) 963-7641



Atlanta Attachment Company

The Company that
Sudden Service®
built



1 Needle, 3 Threads, Carpet Overedging Machine

- Special parts for sewing around curves
- Overedging width of 15mm
- Thick carpet to 15mm

Optional:

- Presser foot and cloth guide for sewing curves (EF423AL-4 only)

www.atlatt.com • sales@atlatt.com

PATENTS: Our equipment may be covered by one or more patents.
Please go to the following web page for an up-to-date patent list: www.atlatt.com/patents.php
© 2017 Atlanta Attachment Co.

362 Industrial Park Drive
Lawrenceville, GA 30046 USA
+1 (770) 963-7369 • FAX +1 (770) 963-7641



Atlanta Attachment Company

The Company that
Sudden Service®
built

Automatic Tubular Tape Feeding Attachment

- Mounting adapts easily to all standard industrial sewing machines
- 4 screws in front of the machine into the tabletop
- SPS Control unit compatible with all current electronic sewing motors
- Installation with connector
- Pneumatic tape cutter
- Tape width 10-38 mm
- Tape brake is controlled electro pneumatically



www.atlatt.com • sales@atlatt.com

PATENTS: Our equipment may be covered by one or more patents.
Please go to the following web page for an up-to-date patent list: www.atlatt.com/patents.php
© 2017 Atlanta Attachment Co.

362 Industrial Park Drive
Lawrenceville, GA 30046 USA
+1 (770) 963-7369 • FAX +1 (770) 963-7641



Atlanta Attachment Company

The Company that
Sudden Service®
built



Automatic CNC Sewing Unit for Sewing of Retainer Strips to Car Seat Covers, Template Controlled, Programmable, Over-Lapping Loading and Unloading

- Automatic sew
- Programmable - up to three different lengths of retainer strips
- Immediate change of programs by template recognition
- Quick and easy template change by operator
- 650mm longarm sewing head
- Backtacking or stitch condensing at beginning and end of seam
- Microprocessor control
- Driven by stepping motors
- Laser light positioning for aid in loading templates
- Lockstitch

3110/1	1x301	2500	9	134-35 to size 120/19
		rpm	mm	

www.atlatt.com • sales@atlatt.com

PATENTS: Our equipment may be covered by one or more patents. Please go to the following web page for an up-to-date patent list: www.atlatt.com/patents.php
© 2017 Atlanta Attachment Co.

362 Industrial Park Drive
Lawrenceville, GA 30046 USA
+1 (770) 963-7369 • FAX +1 (770) 963-7641



Atlanta Attachment Company
The Company that
Sudden Service®
built

Double Chainstitch Sewing Workstation Sewing Pipe seams for Car Seats

- Sewing Head, Single-needle Double chainstitch, type 401
- Electropneumatic seam condensation and presser foot lifter
- SSD Skip Stitch Detection
- EFKA drive motor
- Microprocessor control with program memory
- Seam control via stepping motor with program memory



www.atlatt.com • sales@atlatt.com

PATENTS: Our equipment may be covered by one or more patents.
Please go to the following web page for an up-to-date patent list: www.atlatt.com/patents.php
© 2017 Atlanta Attachment Co.

362 Industrial Park Drive
Lawrenceville, GA 30046 USA
+1 (770) 963-7369 • FAX +1 (770) 963-7641



Atlanta Attachment Company

The Company that
Sudden Service®
built

KMF | 3145/1 & 3145/4







Semi-Automatic Workstation for Attaching Tubular Tape (wire pocket) to Car Seats

- Programmable start and stop of tape
- 1 Needle lockstitch sewing head (301stitch)
- Cycle counter for bobbin change
- Material transported by upper and lower belts, synchronized with sewing head
- Backtacking or stitch condensing at beginning and end of seam
- Material feed by stepping motors
- Sewing head driven by electronic servo motor
- Tape fed from roll underneath machine
- Seam length programmable and variable
- Microprocessor controlled

Optional:

- Laser light positioning guide
- Thread monitor for upper thread
- Chainstitch sewing head

					
3150/1	1x301	2000	8	134-35 to size 120/19	10/3
		rpm	mm		

www.atlatt.com • sales@atlatt.com

PATENTS: Our equipment may be covered by one or more patents. Please go to the following web page for an up-to-date patent list: www.atlatt.com/patents.php
© 2017 Atlanta Attachment Co.

362 Industrial Park Drive
Lawrenceville, GA 30046 USA
+1 (770) 963-7369 • FAX +1 (770) 963-7641



Atlanta Attachment Company
The Company that
Sudden Service®
built

Cutting and Punching Unit for Retainer Strips, Comprising of Roll Feed Mechanism, Punching Unit, Cutting Unit, Microprocessor Controlled and Fully Programmable

- JIT production of retainer strips
- No pre-cut and pre-punched retainers required in inventory
- Sequences of different lengths, holes, and notch locations are freely programmable
- Number of finished parts can be programmed
- Multiple widths can be cut without adjustment (70mm max)
- Finished product disposed into box for easy handling
- Stepper motor driven feeding system

Optional:

- Sewing station for welt type retainer strips (3145/4) Flatbed Chainstitch sewing head with close coupled puller
- Unrolling device to remove welt cord from roll
- Buffer station between unroll and sewing station
- Buffer station between sewing and cut-and-punch station
- Cutter and one punch (standard) additional punches (max 4) with different shapes (v-notch, diamond, half round, oblong)
- Chute disposal into box



www.atlatt.com • sales@atlatt.com

PATENTS: Our equipment may be covered by one or more patents. Please go to the following web page for an up-to-date patent list: www.atlatt.com/patents.php
© 2017 Atlanta Attachment Co.

362 Industrial Park Drive
Lawrenceville, GA 30046 USA
+1 (770) 963-7369 • FAX +1 (770) 963-7641



Atlanta Attachment Company
The Company that
Sudden Service®
built

Mitsubishi | PLGE Series



Computer-Controlled Cycle Machines with Input Functions, Mitsubishi Mini-Servo X 500W Motor Drive, Liquid Crystal Touch-Pad Display for Programming and Control Functions

- Large liquid crystal touch-pad display
- On screen data entry and modification
- Intermittent or continuous feed system (selectable)

Optional:

- Quick change clamping system
- 110 volt
- Fixturing
- High-lift mechanism (foot-lift)
- Programmer stand for PLK-E-PAL programmer
- Stepping foot step adjuster
- Heavy thread trimming system
- PC programming software
- High voltage transformer

Model Number	Sewing Field	
	X (mm)	Y (mm)
PLG-E1010	100	100
PLG-E1010KX	225	100
PLG-E2008H	200	80
PLG-E2010R	200	100
PLG-E2516	250	160
PLG-E2516YU	300	200
PLG-E4030	400	300
PLG-E6030	600	300
PLG-E5050	500	500
PLG-E10050	1000	500

PLGE Series	1x301	2500	0.1-12.7	135x17 to size 140/22	L	9	10/3
		rpm	mm				

www.atlatt.com • sales@atlatt.com

PATENTS: Our equipment may be covered by one or more patents. Please go to the following web page for an up-to-date patent list: www.atlatt.com/patents.php
© 2017 Atlanta Attachment Co.

362 Industrial Park Drive
Lawrenceville, GA 30046 USA
+1 (770) 963-7369 • FAX +1 (770) 963-7641



Atlanta Attachment Company

The Company that
Sudden Service®
built



Triple-Feed Sewing Machine with Vertical Hook

- High traction due to unison feed
- Even feed motion without any ply-shift of individual layers
- Large vertical rotary hook with 60% more capacity than other standard-sized hooks
- Rugged and durable
- The high top feed lift (7.0 mm) allows trouble-free sewing of thick materials and an easy sewing over cross seams
- Easy loading and unloading (even bulky material) due to a high fabric clearance of 14.0 mm

1245	2x301	2800	8	L	14	7	•
		rpm	mm		mm	mm	

www.atlatt.com • sales@atlatt.com

PATENTS: Our equipment may be covered by one or more patents. Please go to the following web page for an up-to-date patent list: www.atlatt.com/patents.php
© 2017 Atlanta Attachment Co.

362 Industrial Park Drive
Lawrenceville, GA 30046 USA
+1 (770) 963-7369 • FAX +1 (770) 963-7641













Atlanta Attachment Company
The Company that
Sudden Service®
built



Triple-feed special high-speed sewing machine with horizontal hook

- Very good seam quality and sewing reliability on assembly and top-stitch work on medium to heavy materials
- Excellent results in top-stitching works
- Ergonomically designed and convenient placed control elements – clear and precise functions
- Bobbin winder for a secure and fast start of the bobbin winding process
- Easy access of all adjustments: Top arm cover and head cover can be removed after unscrewing a few screws
- Dial adjustment of stitch length
- **2235 Basic:** A version without automatic functions
- **2235 Plus:** A version with additional functions (e.g. overload safety clutch, programmable multi-switch, 2 top feed strokes and 2 stitch lengths pre-selectable, etc.)

										
2235	1x301	3000 rpm	9 mm	•	• mm	L	• mm	9 mm	2	345x120 mm

www.atlatt.com • sales@atlatt.com

PATENTS: Our equipment may be covered by one or more patents. Please go to the following web page for an up-to-date patent list: www.atlatt.com/patents.php
© 2017 Atlanta Attachment Co.

362 Industrial Park Drive
Lawrenceville, GA 30046 USA
+1 (770) 963-7369 • FAX +1 (770) 963-7641



Atlanta Attachment Company
The Company that
Sudden Service®
built

Special high-speed seamer with needle feed, wheel feed and roller presser

- Exact stitch lengths, reproducible at any time
- No or highly reduced marking thanks to the material-protecting transport mode (particular with the finest materials or laminates)
- Exceptionally precise material transport via an independent drive of roller presser and wheel feed
- Panel with multi-function buttons and programmable multi-switch for backtacking is integrated in machine head
- Integrated LED light, dimmable
- No material perforation when backtacking
- Switch over to differential feed without sewing stop
- Universal application for thread sizes 80/3 to 10/3synth
- Second thread tension shiftable



2521	2x301	3500	5	•	•	L	10/3
		rpm	mm		mm		

www.atlatt.com • sales@atlatt.com

PATENTS: Our equipment may be covered by one or more patents. Please go to the following web page for an up-to-date patent list: www.atlatt.com/patents.php
© 2017 Atlanta Attachment Co.

362 Industrial Park Drive
Lawrenceville, GA 30046 USA
+1 (770) 963-7369 • FAX +1 (770) 963-7641



Atlanta Attachment Company
The Company that
Sudden Service®
built



Triple-Feed Special High-Speed Sewing Machine with Vertical Hook

- The machine achieves a very high stitch quality both for top-stitching work in the visible areas and for securing and assembly seams
- The ergonomically designed dials guarantee quick and accurate adjustments of the first and second top feed stroke (with automatic speed adaption)
- Programmable multi switch in easy reach of the operator
- Large clearance under the machine
- Bobbin winder for a secure and fast start of the winding process ("winding assistant")
- Easy access of all adjustments: Top arm cover and head cover can be removed after unscrewing a few screws.
- **2545 BASIC:** A version without automatic functions
- **2545 CLASSIC:** Version with one adjustable top feed stroke and one stitch length and automatic speed adaption.

Optional:

- Motor driven edge cutter with a trimming margin of 1.5mm

2545	2x301	3800*	•	12	•	•	XL	•	9	•	345x120
» DOUBLE NEEDLE:											
2546	4x301	3800*	•	12	•	•	XL	•	9	•	345x120
		rpm		mm		mm			mm		mm

www.atlatt.com • sales@atlatt.com

PATENTS: Our equipment may be covered by one or more patents. Please go to the following web page for an up-to-date patent list: www.atlatt.com/patents.php
© 2017 Atlanta Attachment Co.

362 Industrial Park Drive
Lawrenceville, GA 30046 USA
+1 (770) 963-7369 • FAX +1 (770) 963-7641



Atlanta Attachment Company
The Company that
Sudden Service®
built

Postbed sewing machines with unison feed

- Machine for three-dimensional fabrics in the upholstery industry
- Less bobbin changes by the large vertical hook with 60% more thread capacity
- Bobbin winder equipped with an aid for a secure and fast start of the bobbin winding process and within easy reach of the operator ("winding assistant")
- LED light integrated in the sewing head
- Unique service concept. Easy and fast access of all adjustments.
- Integrated panel with multi-function buttons & programmable multi-switch
- Oil-level indicator on the display, with warning light on sewing head



Optional:

- Edge guides
- Material guides
- Folders
- Binder attachments

2595	1x301	2600	12	•	•	L	•	9	10/3	•	
» DOUBLE NEEDLE:											
2596	2x301	2600	12	•	•	L	•	9	10/3	•	
		rpm	mm		mm			mm		mm	

www.atlatt.com • sales@atlatt.com

PATENTS: Our equipment may be covered by one or more patents. Please go to the following web page for an up-to-date patent list: www.atlatt.com/patents.php
© 2017 Atlanta Attachment Co.

362 Industrial Park Drive
Lawrenceville, GA 30046 USA
+1 (770) 963-7369 • FAX +1 (770) 963-7641



Atlanta Attachment Company
The Company that
Sudden Service®
built



Free programmable flatbed computer stitcher

- PFAFF POWERLINE sewing head with a horizontal sewing hook for threads form 80/3 to 20/3
- Hopper foot adjustable from 0 to 9 mm
- programmable in two steps (Standard 4 mm)
- Lift of hopper foot 18 mm
- Thread trimmer with a rest thread end of < 13 mm
- Second thread tension (program controlled)
- Thread nipper ensures a neat seam start (no thread tail on top of the work piece)
- Thread wiper electro-pneumatically controlled
- Intermittend feed system
- Automatic fresh oil supply to the sewing hook

Optional:

- Edge guides
- Material guides
- Folders
- Binder attachments

3108	1x301	2800	12	•	L	20	80/3-20/3
		rpm	mm			mm	

www.atlatt.com • sales@atlatt.com

PATENTS: Our equipment may be covered by one or more patents. Please go to the following web page for an up-to-date patent list: www.atlatt.com/patents.php
© 2017 Atlanta Attachment Co.

362 Industrial Park Drive
Lawrenceville, GA 30046 USA
+1 (770) 963-7369 • FAX +1 (770) 963-7641



Atlanta Attachment Company
The Company that
Sudden Service®
built





Docu seam system (with needle feed + differentiable wheel feed and roller presser)

- Quality assurance system for the production of safety-relevant seams
- In the field car interior the machine is very applicative for seams which have small radii at the formed parts
- Automatical thread-tension device and real-time monitoring of thread force (stitch by stitch)
- Skip stitch recognition inside and outside of documented seams
- Electronic thread tension adjustment (no manual adjustment necessary)
- Sewing head recognition
- Operation of all functions with touch-screen
- Free label design
- Programmable stitch length (in each seam sector)
- Scanner for thread and label control



Optional:

- Seam width control with sensor-controlled edge guide
- Thread force calibration
- Motor-driven edge cutter with smallest edge distance of 1.5 mm

					
3721	1x301	•	5	•	L
mm					

www.atlatt.com • sales@atlatt.com

PATENTS: Our equipment may be covered by one or more patents. Please go to the following web page for an up-to-date patent list: www.atlatt.com/patents.php
© 2017 Atlanta Attachment Co.

362 Industrial Park Drive
Lawrenceville, GA 30046 USA
+1 (770) 963-7369 • FAX +1 (770) 963-7641



Atlanta Attachment Company
The Company that
Sudden Service®
built



Docu seam system with unison feed

- Quality assurance system for the production of safety-relevant seams
- Automatic thread-tension device and real-time monitoring of thread force (stitch by stitch)
- Skip stitch recognition inside and outside of documented seams
- Electronic thread tension adjustment (no manual adjustment necessary)
- Sewing head recognition
- Free label design
- Programmable top feed lift and programmable stitch length (in each seam sector)

Optional:

- Seam width control with sensor-controlled edge guide
- Thread force calibration
- Motor-driven edge cutter with smallest edge distance of 1.5 mm



3745	1x301	•	•	•	•	L/XL	20	9
					mm		mm	mm

www.atlatt.com • sales@atlatt.com

PATENTS: Our equipment may be covered by one or more patents. Please go to the following web page for an up-to-date patent list: www.atlatt.com/patents.php
© 2017 Atlanta Attachment Co.

362 Industrial Park Drive
Lawrenceville, GA 30046 USA
+1 (770) 963-7369 • FAX +1 (770) 963-7641



Atlanta Attachment Company

The Company that
Sudden Service®
built

Heavy duty, Single Needle, Two Thread, Double Chainstitch Sewing Machine, with Unison Feed

- High Speed
- In-line Loopers
- Unison feed, (bottom feed, needle feed, alternating presser feet)
- Semi-Automatic Lubrication

Optional:

- Edge guides
- Material guides
- Folders
- Binder attachments
- Custom gauge sets
- Custom puller assemblies



300U-194A	1x301	4000	1-8	62x59	36.5	270	11
		rpm	mm		mm	mm	mm

www.atlatt.com • sales@atlatt.com

PATENTS: Our equipment may be covered by one or more patents.
Please go to the following web page for an up-to-date patent list: www.atlatt.com/patents.php
© 2017 Atlanta Attachment Co.

362 Industrial Park Drive
Lawrenceville, GA 30046 USA
+1 (770) 963-7369 • FAX +1 (770) 963-7641



Atlanta Attachment Company
The Company that
Sudden Service®
built



Computer-Controlled, Independent Direct Drive, Beam Frame, Split-Head Construction, Pattern Sewing Machine, Operation Panel Direct Programming

- Sew field range - 800mm x 500mm
- Box Beam construction
- Split sewing head, upper shaft and lower shaft separately driven by independent servo motors
- High head lifter (50mm)
- Template recognition
- Quick change clamp
- High clamp lift (80mm)
- Upper thread holder
- Thread trimmer

Optional:

- Programming software
- 880 x 580 sew field expansion

SPS/C-8050H	1x301	2300	0.1-12.7	DPx17 DPx15	41.2	XL	22	4	10/3
		rpm	mm		mm		mm		

www.atlatt.com • sales@atlatt.com

PATENTS: Our equipment may be covered by one or more patents. Please go to the following web page for an up-to-date patent list: www.atlatt.com/patents.php
© 2017 Atlanta Attachment Co.

362 Industrial Park Drive
Lawrenceville, GA 30046 USA
+1 (770) 963-7369 • FAX +1 (770) 963-7641



Atlanta Attachment Company
The Company that
Sudden Service®
built

Tooling for the SunStar® SPS/C-8050H

- Custom tooling to sew large, irregular pieces
- Consistent, uniform stitching improves appearance of finished part
- Machine sews as operator loads next piece; in many cases operators can run two machines
- Cassette tooling allows machine to sew multiple styles on one machine
- Clamp recognition, available on some models, allows the machine to sew the correct pattern for that particular cassette

Optional:

- Edge guides
- Material guides
- Folders
- Binder attachments



www.atlatt.com • sales@atlatt.com

PATENTS: Our equipment may be covered by one or more patents.
Please go to the following web page for an up-to-date patent list: www.atlatt.com/patents.php
© 2017 Atlanta Attachment Co.

362 Industrial Park Drive
Lawrenceville, GA 30046 USA
+1 (770) 963-7369 • FAX +1 (770) 963-7641



Atlanta Attachment Company

The Company that
Sudden Service®
built

Custom Designed Equipment

Working alongside our affiliate company, Atlanta Precision Machining and Fabrication, we can make any custom die for all your tooling needs.

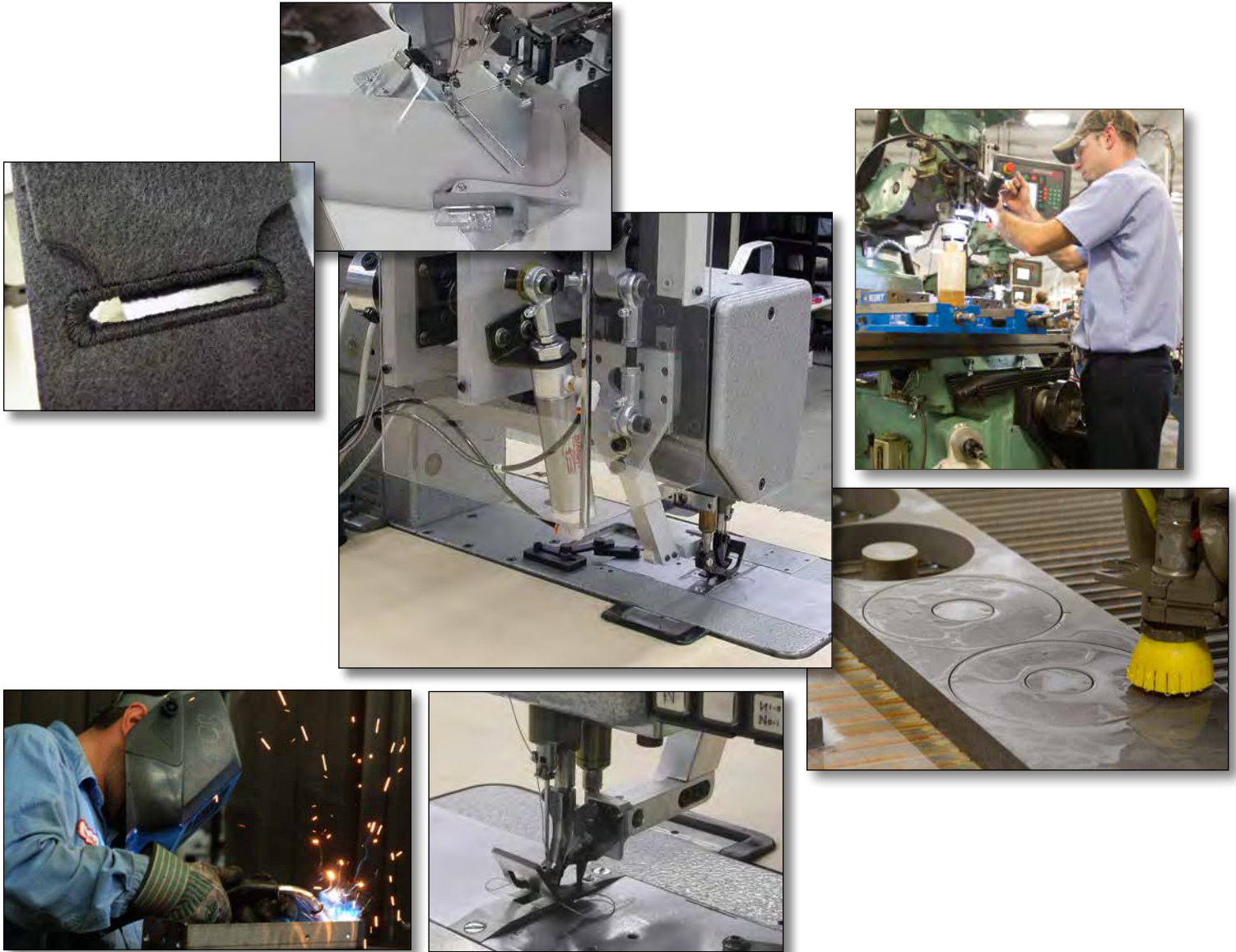

EQUIPMENT LIST:

17 CNC Milling Centers
7 CNC Turning Centers
10 Trak K3 Programmable Mills
5 Manual Lathes

4 Surface Grinders
4 Break Presses
3 Lasers
1 Water Jet

7 Welding Booths
1 Sand Blast Booth
1 Black Oxide Tank
1 Wet Paint Line.

www.atlatt.com • sales@atlatt.com

PATENTS: Our equipment may be covered by one or more patents. Please go to the following web page for an up-to-date patent list: www.atlatt.com/patents.php
© 2017 Atlanta Attachment Co.

362 Industrial Park Drive
Lawrenceville, GA 30046 USA
+1 (770) 963-7369 • FAX +1 (770) 963-7641



Atlanta Attachment Company
The Company that
Sudden Service®
built

Custom Designed Equipment

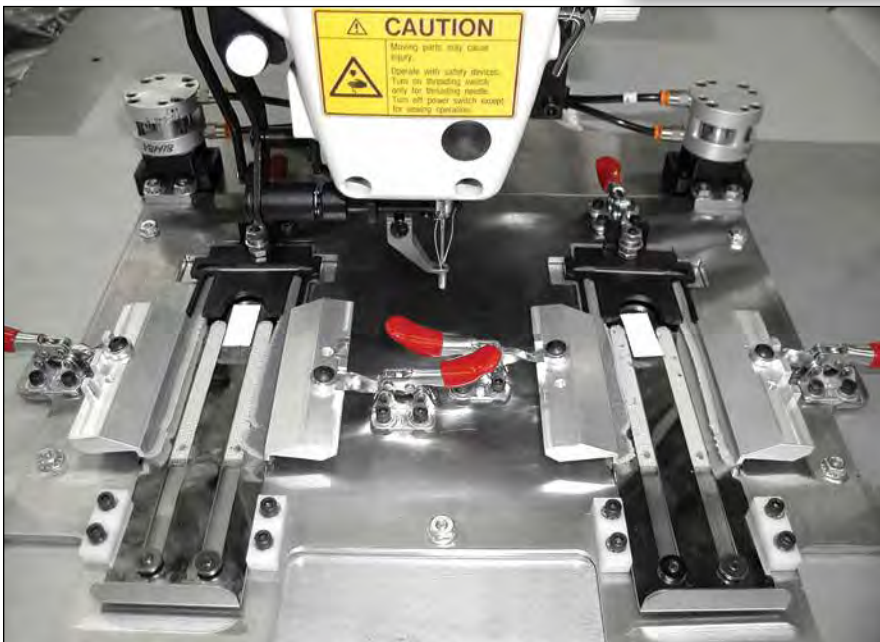
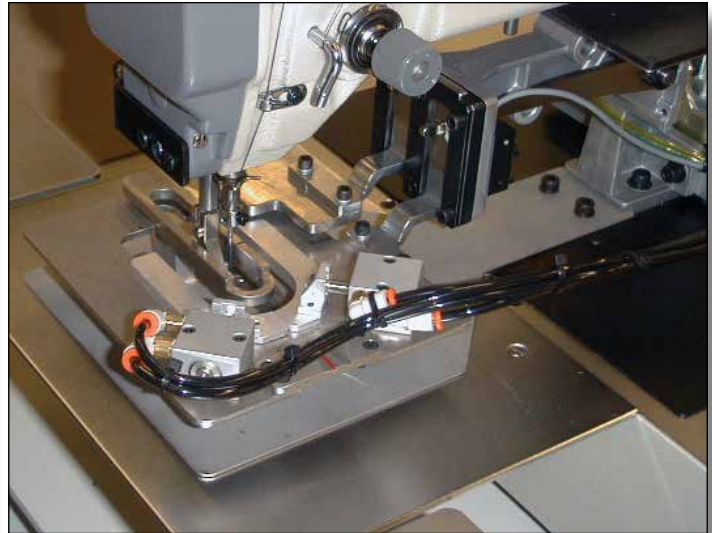

www.atlatt.com • sales@atlatt.com

PATENTS: Our equipment may be covered by one or more patents. Please go to the following web page for an up-to-date patent list: www.atlatt.com/patents.php
© 2017 Atlanta Attachment Co.

362 Industrial Park Drive
Lawrenceville, GA 30046 USA
+1 (770) 963-7369 • FAX +1 (770) 963-7641



Atlanta Attachment Company
The Company that
Sudden Service®
built

Ergo-Components

Tables

- All shapes and sizes available from 20"x48" rectangular, to 48"x60" L-shape
- Custom sizes available by special order
- Custom engineered air tables



Stands

- Sit-down operation T-Legs
- Stand-up operation T-Legs (reinforced)
- Ergo stands with manual or electric height adjustment
- All stands available with casters



Pedals

- Sit-down pedals for Clutch or Electronic motors
- Stand-up Pedals
- Various configurations from 1 to 4 pedals to control all or individual functions
- Custom pedals manufactured to customer specification.



Motors

- EFKA, Juki, Panasonic, Mitsubishi and Quick
- 110/220 Volt Clutch
- 110/220 Electronic Servo (AC and DCs)
- Choice of control panels and synchronizers



www.atlatt.com • sales@atlatt.com

PATENTS: Our equipment may be covered by one or more patents. Please go to the following web page for an up-to-date patent list: www.atlatt.com/patents.php
© 2017 Atlanta Attachment Co.

362 Industrial Park Drive
Lawrenceville, GA 30046 USA
+1 (770) 963-7369 • FAX +1 (770) 963-7641



Atlanta Attachment Company
The Company that
Sudden Service®
built

Attachments & Folders

All Standard Sizes Available in Stock

Custom Orders Made in 5-7 Days *from customer supplied sample*



Binding Attachments



Block Binding

Hemming Attachments



Welting Attachments

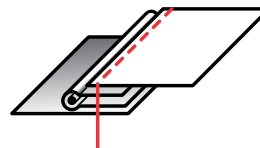
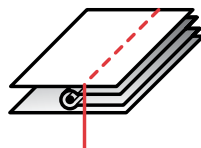

Zipper Attachments

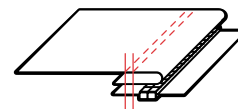
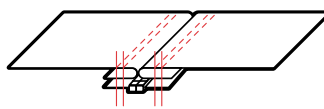

*This is a small sample of our standard and custom attachments.
Contact sales for a complete list of products.*

www.atlatt.com • sales@atlatt.com

PATENTS: Our equipment may be covered by one or more patents.
Please go to the following web page for an up-to-date patent list: www.atlatt.com/patents.php
© 2017 Atlanta Attachment Co.

362 Industrial Park Drive
Lawrenceville, GA 30046 USA
+1 (770) 963-7369 • FAX +1 (770) 963-7641



Atlanta Attachment Company

The Company that
Sudden Service[®]
built

Serial Bus Control System

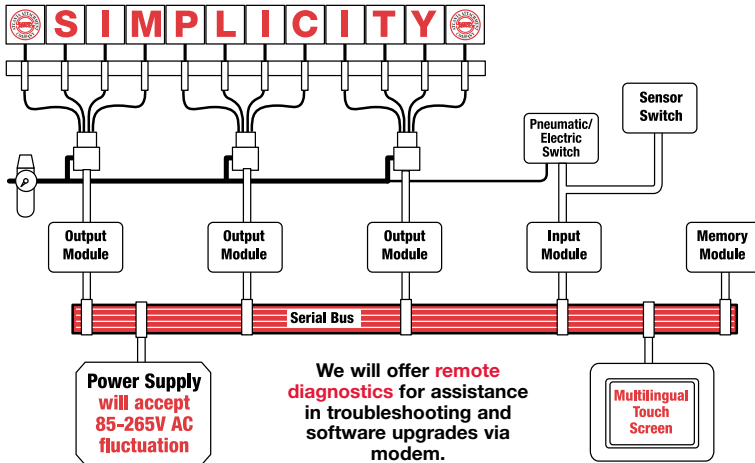

Automated Sewing Equipment with the Patented Serial Bus Control System

Our new Serial Bus Control System is a quantum change for our automated sewing equipment **and** the sewn products industry. Our Serial Bus System, based on only four wires, is self-diagnostic and offers helpful solutions to solve the problem.

An operator using a touch screen control panel manages this rugged, uncomplicated system. Designed to international standards, this multi-lingual, easy to operate interface will allow numerical parameters to be saved, allow technician access with password protection and offers a built-in production performance monitor which can be networked to a central computer.

Unconditional Warranty 3 Years Unconditional... Period!

A warranty is a fulfillment promise to be honored with pride. At Atlanta Attachment Company we are proud to honor our new 3 Year Warranty which is unsurpassed in the industry. This warranty covers all electrical components of the state-of-the-art Serial Bus Control System used on our Automated Sewing Workstations.

Patented

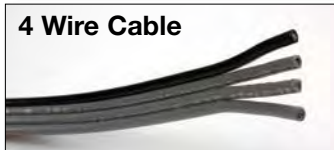

www.atlatt.com • sales@atlatt.com

PATENTS: Our equipment may be covered by one or more patents. Please go to the following web page for an up-to-date patent list: www.atlatt.com/patents.php
© 2017 Atlanta Attachment Co.

362 Industrial Park Drive
Lawrenceville, GA 30046 USA
+1 (770) 963-7369 • FAX +1 (770) 963-7641



Atlanta Attachment Company
The Company that
Sudden Service[®]
built

Automated Parts Management System

- Multi-access drawer modules
- High storage capacity with minimal footprint
- 24/7 secure access
- Touchscreen interface
- Emergency override in case of power failure
- Modular design/easily configurable
- Expandable add-on units
- Comprehensive reporting
- Automated replenishment

Technical Information

Software provides full inventory management with complete control, reordering, audit trail and reporting capability and is ready to connect to your network for analysis and management of your crib activity.

Options

- **APS2** - Parts Cabinet
- **APS3** - Parts and Equipment Locker



Drawer-based dispensing requires NO repackaging and does not drop items



Models from left to right:
APS1 Multi Access
 Drawer Module
APS2 Parts Cabinet
APS3 Parts & Equipment
 Locker

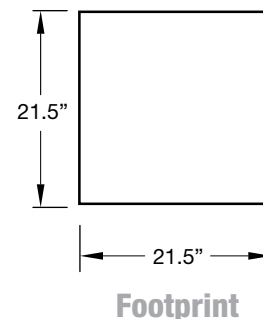

Mix and match any configuration with multiple units to fit the needs of your plant

www.atlatt.com • sales@atlatt.com

PATENTS: Our equipment may be covered by one or more patents. Please go to the following web page for an up-to-date patent list: www.atlatt.com/patents.php
 © 2017 Atlanta Attachment Co.

362 Industrial Park Drive
 Lawrenceville, GA 30046 USA
 +1 (770) 963-7369 • FAX +1 (770) 963-7641



Atlanta Attachment Company
 The Company that
Sudden Service®
 built



One-Stop Shopping for Replacement Parts

Atlanta Parts Depot™

A Division of Atlanta Attachment Company®

Supplier of expendable replacement parts for all major sewing equipment companies.

- Atlanta Attachment Company
- Brother
- Cash
- Consew
- Durkopp Adler
- Efka
- Galkin
- Gribetz
- Groz-Beckert
- Illinois Tool Works
- Juki
- Meistergram
- Mitsubishi
- Organ
- Pegasus
- Pfaff
- Porter
- Schmetz
- Singer
- SunStar
- Tajima
- Union Special
- United
- Willcox & Gibbs
- Yamato

We also offer glue, oil, silicone and other accessories.



PARTS SHIP WITHIN 72 HOURS OR IT'S FREE!*
THIS IS A PROMISE

* For over 26 years, AAC has been offering our "72 hours or FREE" pledge to our customers. This promise makes us the leading supplier of parts and automated sewing workstations. We promise unequalled service and support and to maintain inventories of the recommended spare parts for our automated workstations. We will ship those replacement parts within 72 hours and if the expendable replacement parts are not shipped within 72 hours they will be... **Free of Charge!**

Contact sales for the recommended spare parts list and the model workstations covered.

PATENTS: Our equipment may be covered by one or more patents. Please go to the following web page for an up-to-date patent list: www.atlatt.com/patents.php
 © 2017 Atlanta Attachment Co.

362 Industrial Park Drive
 Lawrenceville, GA 30046 USA
 +1 (770) 963-7369 • FAX +1 (770) 963-7641

The Company that
Sudden Service®
 built



Atlanta Parts Depot

FAX Order Form
770-963-7641

BILL TO

Account No: _____

Company: _____ REQUIRED
 Contact: _____
 Address A: _____
 Address B: _____
 Address C: _____
 City: _____
 State: _____ ZIP: _____
 Country: _____
 Phone: _____
 FAX: _____
 Email: _____

SHIP TO

Company: _____ REQUIRED:
If different than "BILL TO"
 Contact: _____
 Address A: _____
 Address B: _____
 Address C: _____
 City: _____
 State: _____ ZIP: _____
 Country: _____
 Phone: _____
 FAX: _____
 Email: _____

Ordered By : _____ REQUIRED
 PO No: _____ REQUIRED

Phone: _____
 FAX: _____
 Email: _____

QTY	PART NO.	DESCRIPTION	U/M	PRICE	EXT PRICE

SHIPPING INSTRUCTIONS

Shipping, taxes and International documentation fees will be calculated and added when applicable.

Sub Total

UPS:
 Acc # _____
 Ground
 Red AM
 Blue
 Orange

FedX:
 Acc # _____
 Ground
 Air
 Collect

Other:
 Acc # _____

Credit Card: # _____
 VISA MC DISC AEXP
 Name: _____
 Exp Date: _____
 Phone No: _____

www.atlatt.com • sales@atlatt.com
 Website: www.atlantapartsdepot.com



Atlanta Attachment Company
 The Company that
866-885-5100®

PATENTS: Our equipment may be covered by one or more patents.
 Atlanta Parts Depot
 362 Industrial Park Drive
 Lawrenceville, GA 30046 USA



Atlanta Parts Depot is a division of Atlanta Attachment Company
 © 2012 Atlanta Attachment Company



Website: www.atlatt.com email: sales@atlatt.com

Atlanta Attachment Company
362 Industrial Park Drive
Lawrenceville, GA 30046
+1 (770) 963-7369 • FAX +1 (770) 963-7641